

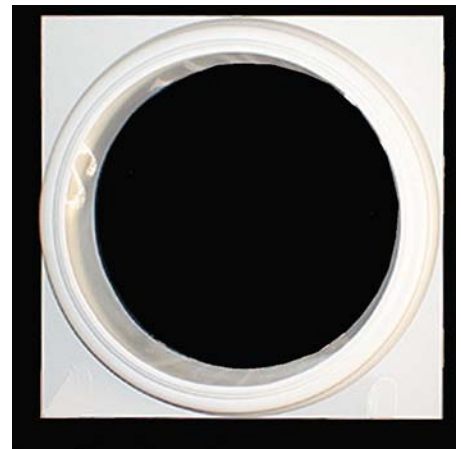

Tuscan Base

IPPCTB18 Polymer Composite

Martin Richards Design
COLLECTION

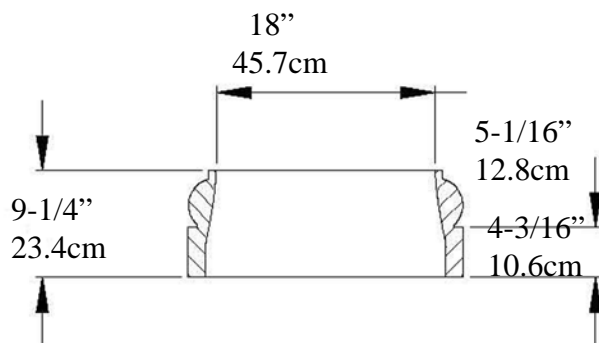
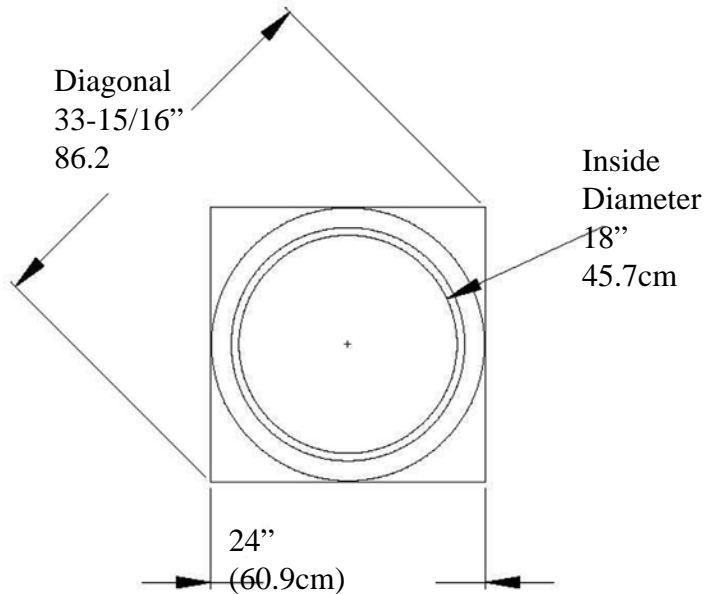

Weight 47 lb (21.3 kg)

* All specifications subject to change without notice,
Final products & Measurements may vary from this brochure Manufacturing tolerences +- 1/8" (.31cm)



www.imperialarchitecture.com

Imperial Productions & Distribution Inc Toronto / New York

email sales@imperialproductions.com copyright 2016 MRDCI All Rights Reserved

1-800-399-7585

Fall 2018