



Imperial Productions®



Doric Capitals

Decorative



ImperialProductions®

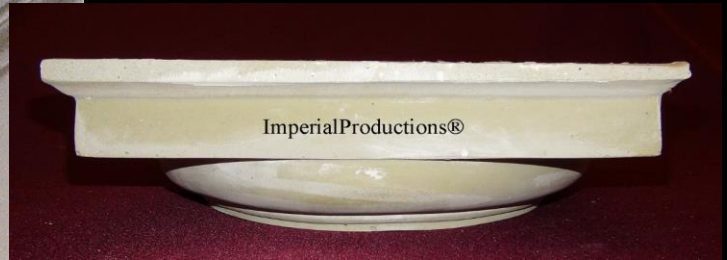

SPLIT OPTIONS



IPPCTC06	Hole 5-1/4"		
EconPolymer™	List	Each	6 +
Whole	23.34	17.51	14.01
Split in Half (Pilaster)	27.74	20.81	16.65
Whole White Painted	35.95	26.96	21.57
Split in Half White Painted	40.35	30.26	24.21

ITEM 1

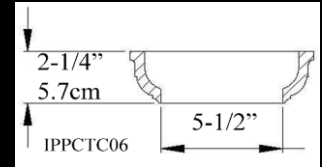
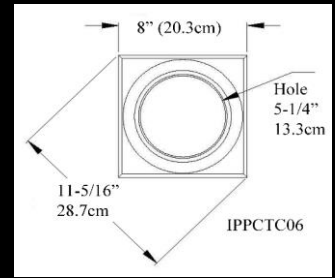

Cap (EconPolymer)

[click for Brochure/Order Form](#)

IPPCTC08	Hole 6-1/4"		
EconPolymer™	List	Each	6 +
Whole	23.52	17.64	14.11
Split in Half (Pilaster)	35.68	26.76	21.41
Whole White Painted	41.60	31.20	24.96
Split in Half White Painted	53.79	40.34	32.27

ITEM 2

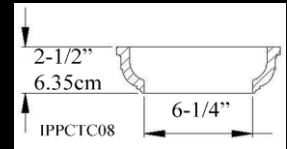
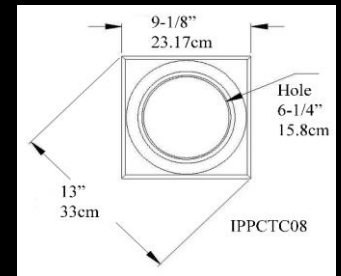

Cap (EconPolymer)

[click for Brochure/Order Form](#)

IPDC08	Hole 6-1/2"		
FRP-PolyComp™	List	Each	6 +
Whole	57.28	42.96	34.37
Split for Post Wrap	73.57	55.18	44.14
Split in Half (Pilaster)	73.91	55.43	44.34

ITEM 9

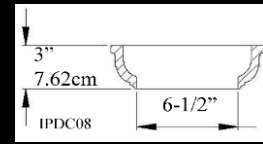
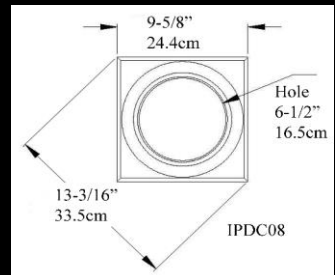

Cap (EconPolymer)

[click for Brochure/Order Form](#)



IPPCTC08NT	Hole 7-5/8"		
EconPolymer™	List	Each	6 +
Whole	21.12	15.84	12.67
Split in Half (Pilaster)	26.73	20.05	16.04
Whole White Painted	39.23	29.42	23.54
Split in Half White Painted	44.84	33.63	26.90

ITEM 2

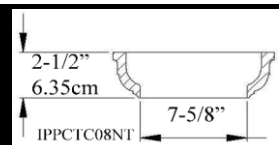
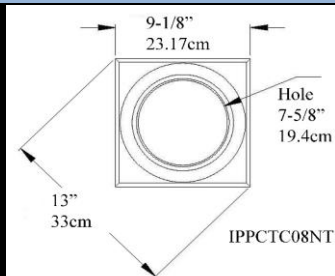

Cap (EconPolymer)

[click for Brochure/Order Form](#)



IPDC10	Hole 7-3/4"		
FRP-PolyComp™	List	Each	6 +
Whole	60.27	45.20	36.16
Split for Post Wrap	76.56	57.42	45.93
Split in Half (Pilaster)	76.91	57.68	46.14

ITEM 9

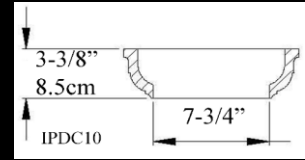
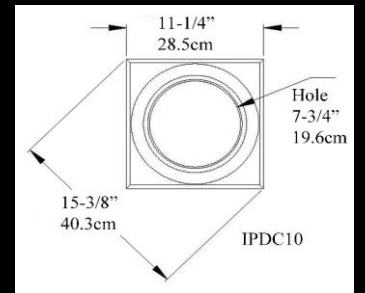

[click for Brochure/Order Form](#)

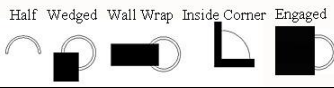

IPPCTC10	Hole 8-1/8"		
EconPolymer™	List	Each	6 +
Whole	33.64	25.23	20.18
Split in Half (Pilaster)	41.12	30.84	24.67
Whole White Painted	61.23	45.92	36.74
Split in Half White Painted	68.73	51.55	41.24

ITEM 2

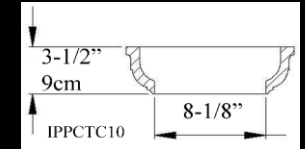
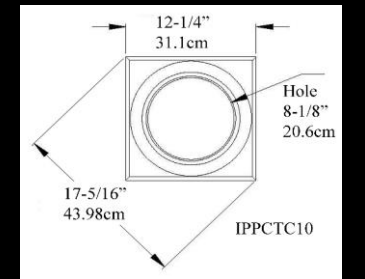

[click for Brochure/Order Form](#)

Cap (EconPolymer)

IPDC12	Hole 9-1/2"		
FRP-PolyComp™	List	Each	6 +
Whole	137.78	103.33	82.67
Split for Post Wrap	154.06	115.55	92.44
Split in Half (Pilaster)	154.77	116.07	92.86

ITEM 9

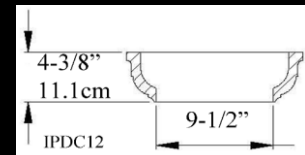
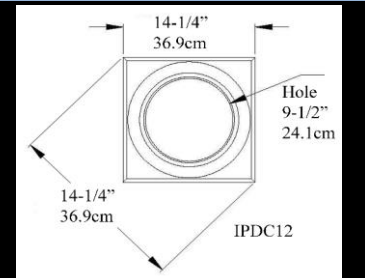

[click for Brochure/Order Form](#)



IPPCTC12	Hole 9-5/8"		
EconPolymer™	List	Each	6 +
Whole	45.10	33.83	27.06
Split in Half (Pilaster)	54.85	41.13	32.91
Whole White Painted	92.44	69.33	55.47
Split in Half White Painted	102.19	76.64	61.31

ITEM 2

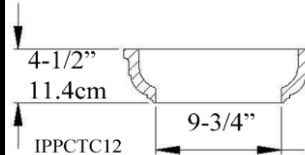
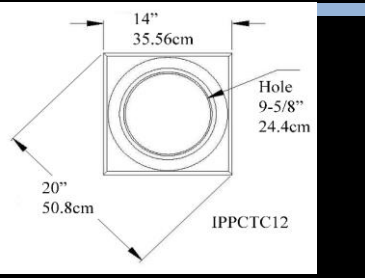

[click for Brochure/Order Form](#)

Cap (EconPolymer)



IPPCTC10NT	Hole 9-7/8"		
EconPolymer™	List	Each	6 +
Whole	33.64	25.23	20.18
Split in Half (Pilaster)	38.06	28.55	22.84
Whole White Painted	61.23	45.92	36.74
Split in Half White Painted	65.65	49.24	39.39

ITEM 2

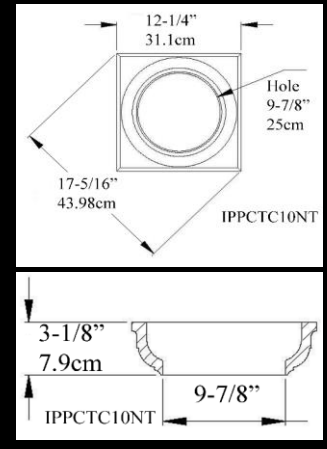

Cap (EconPolymer)

[click for Brochure/Order Form](#)

IPDC14	Hole 11-3/4"		
FRP-PolyComp™	List	Each	6 +
Whole	396.63	297.47	237.98
Split for Post Wrap	412.92	309.69	247.75
Split in Half (Pilaster)	414.80	311.10	248.88

ITEM 9

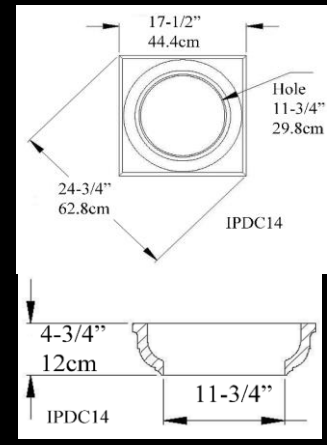

Cap (EconPolymer)

[click for Brochure/Order Form](#)



IPPCTC12NT	Hole 11-3/4"		
EconPolymer™	List	Each	6 +
Whole	45.14	33.86	27.09
Split in Half (Pilaster)	54.85	41.13	32.91
Whole White Painted	92.47	69.35	55.48
Split in Half White Painted	102.19	76.64	61.31

ITEM 2

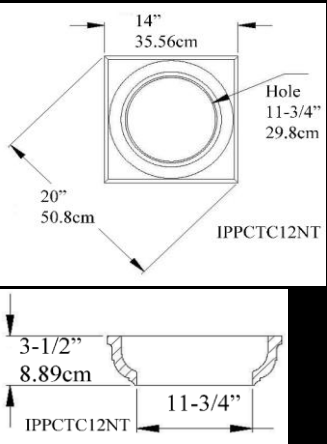

Cap (EconPolymer)

[click for Brochure/Order Form](#)

IPPCTC14	Hole 12-1/8"		
EconPolymer™	List	Each	6 +
Whole	100.74	75.55	60.44
Split in Half (Pilaster)	113.43	85.07	68.06
Whole White Painted	153.16	114.87	91.90
Split in Half White Painted	165.86	124.39	99.51

ITEM 2

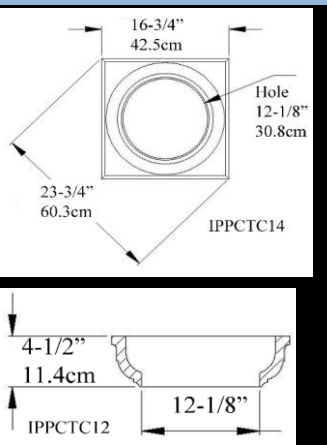

Cap (EconPolymer)

[click for Brochure/Order Form](#)



IPPCTC16	Hole 14"		
EconPolymer™	List	Each	6 +
Whole	127.97	95.98	76.78
Split in Half (Pilaster)	144.45	108.34	86.67
Whole White Painted	188.47	141.36	113.08
Split in Half White Painted	204.95	153.71	122.97

ITEM 2

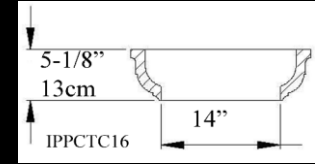
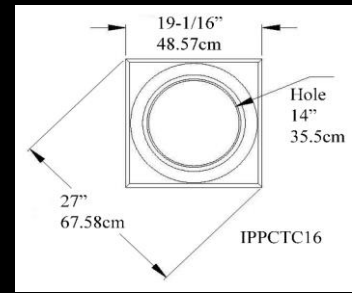

Cap (EconPolymer)

[click for Brochure/Order Form](#)

IPPCTC14NT	Hole 14-1/8"		
EconPolymer™	List	Each	6 +
Whole	100.76	75.57	60.46
Split in Half (Pilaster)	113.43	85.07	68.06
Whole White Painted	153.19	114.89	91.91
Split in Half White Painted	165.86	124.39	99.51

ITEM 2

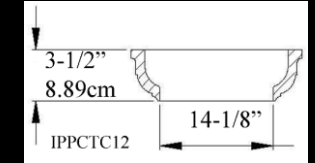
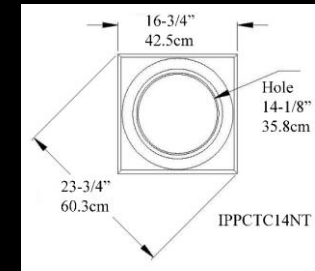

Cap (EconPolymer)

[click for Brochure/Order Form](#)

IPDC16	Hole 14-1/4"		
FRP-PolyComp™	List	Each	6 +
Whole	417.94	313.46	250.77
Split for Post Wrap	470.34	352.75	282.20
Split in Half (Pilaster)	472.48	354.36	283.49

ITEM 9

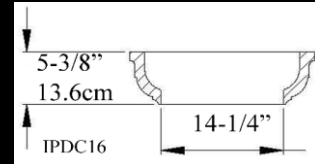
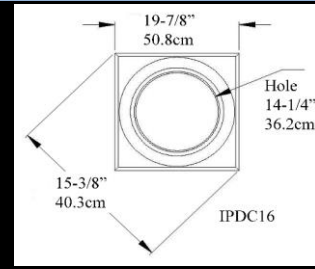

[click for Brochure/Order Form](#)

Half Wedged Wall Wrap Inside Corner Engaged



IPPCTC18	Hole 15-3/4"		
EconPolymer™	List	Each	6 +
Whole	237.25	177.94	142.35
Split in Half (Pilaster)	258.65	193.99	155.19
Whole White Painted	311.67	233.76	187.00
Split in Half White Painted	333.10	249.83	199.86

ITEM 2

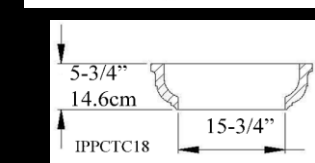
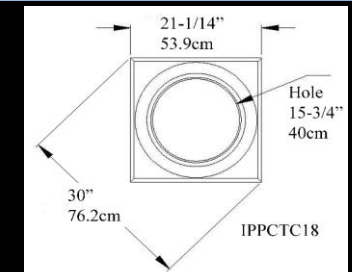

Cap (EconPolymer)

[click for Brochure/Order Form](#)



IPDC18	Hole 16"			
	FRP-PolyComp™	List	Each	6 +
Whole	590.06	442.55	354.04	
Split for Post Wrap	642.46	481.84	385.47	
Split in Half (Pilaster)	645.38	484.03	387.23	

ITEM 9

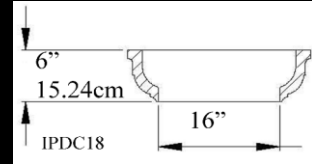
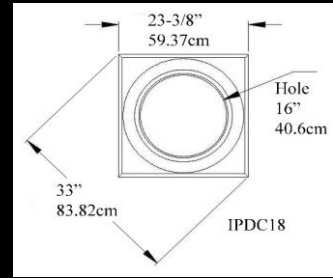

[click for Brochure/Order Form](#)



IPPCTC20	Hole 16-3/4"			
	EconPolymer™	List	Each	6 +
Whole	260.24	195.18	156.14	
Split in Half (Pilaster)	288.05	216.03	172.83	
Whole White Painted	351.87	263.90	211.12	
Split in Half White Painted	379.68	284.76	227.81	

ITEM 2

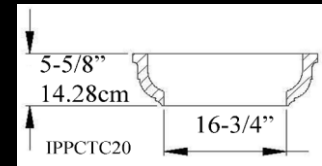
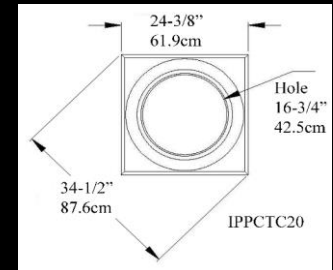

[click for Brochure/Order Form](#)

Cap (EconPolymer)



IPDC20	Hole 17-1/2"			
	FRP-PolyComp™	List	Each	6 +
Whole	673.95	505.46	404.37	
Split for Post Wrap	755.66	566.75	453.40	
Split in Half (Pilaster)	759.10	569.32	455.46	

ITEM 9

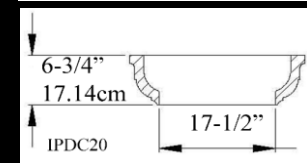
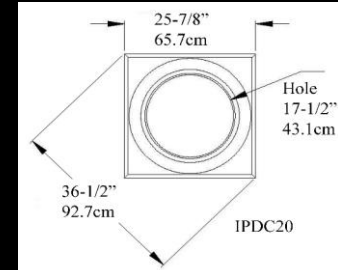

[click for Brochure/Order Form](#)



IPDC22	Hole 19"			
	FRP-PolyComp™	List	Each	6 +
Whole	785.93	589.45	471.56	
Split for Post Wrap	867.65	650.74	520.59	
Split in Half (Pilaster)	871.59	653.70	522.96	

ITEM 9

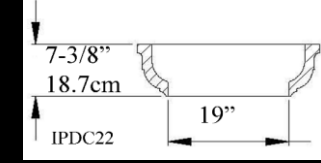
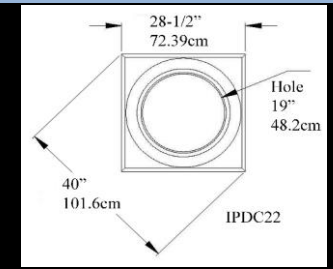

[click for Brochure/Order Form](#)

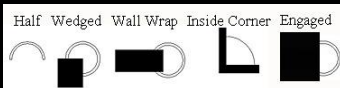



IPPCTC24	Hole 20-1/2"		
EconPolymer™	List	Each	6 +
Whole	609.88	457.41	365.93
Split in Half (Pilaster)	646.07	484.56	387.64
Whole White Painted	728.34	546.23	436.99
Split in Half White Painted	764.48	573.36	458.69

ITEM 2

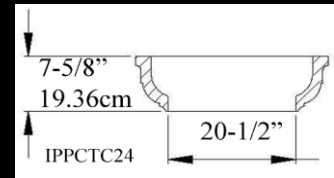
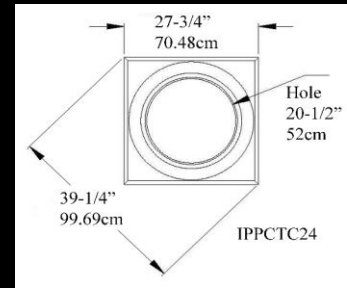

Cap (EconPolymer)

[click for Brochure/Order Form](#)

IPDC24	Hole 20-1/2"		
FRP-PolyComp™	List	Each	6 +
Whole	934.57	700.93	560.74
Split for Post Wrap	1016.29	762.24	609.77
Split in Half (Pilaster)	1020.90	765.68	612.54

ITEM 9

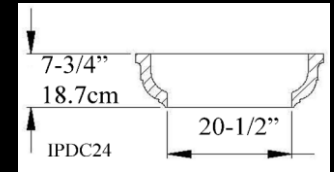
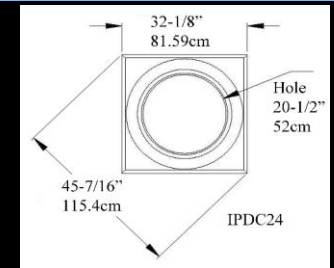

[click for Brochure/Order Form](#)



IPDC30	Hole 27-1/2"		
FRP-PolyComp™	List	Each	6 +
Whole	1210.94	908.20	726.56
Split for Post Wrap	1292.65	969.49	775.59
Split in Half (Pilaster)	1298.53	973.90	779.12

ITEM 9

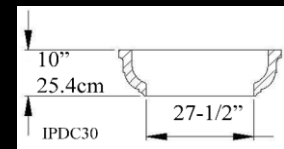
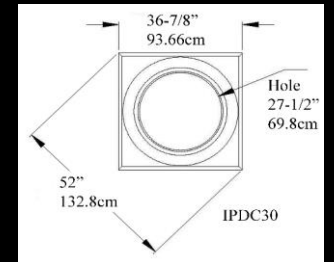

[click for Brochure/Order Form](#)





Doric Capital - Custom Form

Hardwood or Composite

D=Top Square Height ----->

E=Mid Square Height ----->

F=Ovolo Round Height ----->



G=Ovolo Diameter Outside

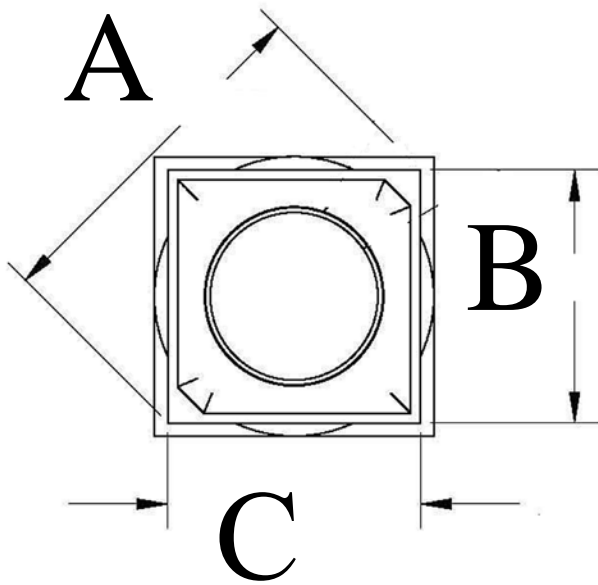

A = _____

B = _____

C = _____

D = _____

E = _____

F = _____

G = _____

TAG NAME

* All specifications subject to change without notice, Final products & Measurements may vary from this brochure



Imperial Productions®

1-800-399-7585

Imperial Productions & Distribution Inc Toronto / New York

email sales@imperialproductions.com copyright 2016 MRDCI All Rights Reserved

MAY-21



Imperial Productions® Request for Quote

Download, Fill-in & Email to sales@imperialproductions.com

Name / Company: _____

Phone _____ Email _____

Billing Address: _____

City: _____ Prov / State _____

PC / Zip Code _____

Ship to Address: _____

City: _____ Prov / State _____

PC / Zip Code _____

Product Code: _____

Quantity: _____

Notes: _____



Imperial Productions®

1-800-399-7585

Imperial Productions & Distribution Inc Toronto / New York

email sales@imperialproductions.com copyright 2016 MRDCI All Rights Reserved