



Imperial Productions®



Roman Corinthian Columns

5 Feet to 10 Feet Load Bearing and Decorative



Roman Corinthian is a classical style Denoted by Acanthus Leaves. They are thought to be derived by the proportions of a person carrying a basket of acanthus leaves Shafts can be smooth or Fluted The appropriate base is the Attic Style



Half Wedged Wall Wrap Inside Corner Engaged



SPLIT OPTIONS

ImperialProductions®



IPPC0508S-ABRC	Load Bearing 63-1/2"		
FRP-PolyComp™	List	Each	50 +
Whole	748.09	561.07	448.85
Split for Post Wrap	821.52	616.14	492.91
Whole Painted White	888.25	666.19	532.95
Split Painted White	964.69	721.26	577.01
Split Wraps Round Steel Post 3-1/2"			

ITEM 5-1

Brochure/Order Form

Custom RomanCorinthian



Total Height IPPC0508S-ABRC
63-1/2" (161cm)
Load Bearing to 10,000lbs (4.5359 mtons)
Top of Shaft
O/D 6-1/8" (15.5cm)
I/D 5-3/8" (13.65cm)
Bottom of Shaft
O/D 7-5/8" (19.36cm)
Attic Base - Hollow
Height 4-5/8" (11.74cm)

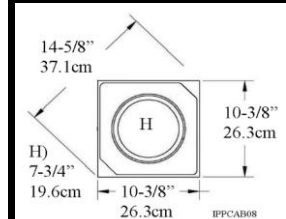
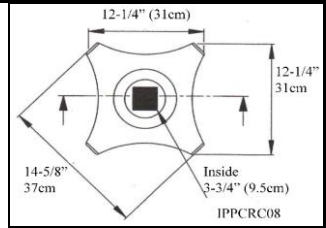

IPPC0608S-ABRC	Load Bearing 75-1/2"		
FRP-PolyComp™	List	Each	50 +
Whole	768.66	576.49	461.19
Split for Post Wrap	842.09	631.57	505.26
Whole Painted White	936.83	702.62	562.10
Split Painted White	1010.26	757.70	606.16
Split Wraps Round Steel Post 3-1/2"			

ITEM 6-1

Brochure/Order Form

Custom RomanCorinthian



Total Height IPPC0608S-ABRC
75-1/2" (192cm)
Load Bearing to 10,000lbs (4.5359 mtons)
Top of Shaft
O/D 6-1/8" (15.5cm)
I/D 5-3/8" (13.65cm)
Bottom of Shaft
O/D 7-5/8" (19.36cm)
Attic Base - Hollow
Height 4-5/8" (11.74cm)

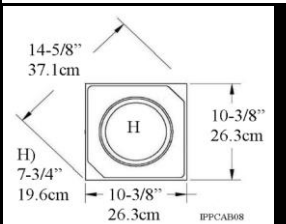
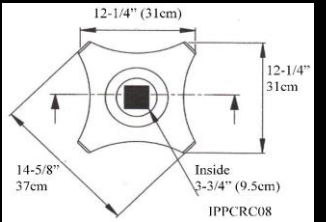

IPPC0610S-ABRC	Load Bearing 78"		
FRP-PolyComp™	List	Each	50 +
Whole	1079.45	809.59	647.67
Split for Post Wrap	1171.57	878.67	702.94
Whole Painted White	1307.15	980.36	784.29
Split Painted White	1399.24	1049.43	839.55
Split Wraps 4x4PT, Round Steel Post 4 to 5-1/2"			

ITEM 6-2

Brochure/Order Form

Custom RomanCorinthian



Total Height IPPC0610S-ABRC
78" (198cm)
Load Bearing to 14,000 lbs (6.35 mtons)
Top of Shaft
O/D 8" (20.3cm)
I/D 7-1/4" (18.4 cm)
Bottom of Shaft
O/D 9-5/8" (24.4 cm)
Attic Base - Hollow
Height 5-5/8" (14.28cm)

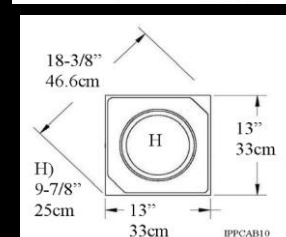
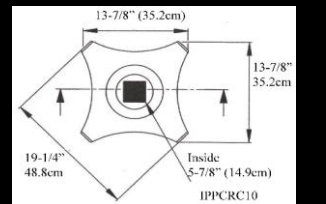

IPPC0612S-ABRC	Load Bearing 79"		
FRP-PolyComp™	List	Each	50 +
Whole	1412.77	1059.58	847.66
Split for Post Wrap	1508.52	1131.39	905.11
Whole Painted White	1716.84	1287.63	1030.10
Split Painted White	1812.58	1359.44	1087.55
Split Wraps 4x4PT, Round Steel Post 4 to 6-1/2"			

ITEM 6-3

Brochure/Order Form

Custom RomanCorinthian

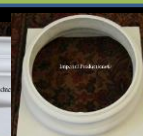

Total Height IPPC0612S-ABRC
79" (200cm)
Load Bearing to 14,000 lbs (6.35 mtons)
Top of Shaft
O/D 9-3/8" (23.8cm)
I/D 8-5/8" (21.9cm)
Bottom of Shaft
O/D 11-1/2" (29.2 cm)
Attic Base - Hollow
Height 6-3/8" (16.1cm)

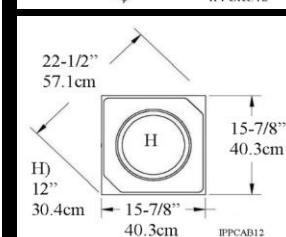
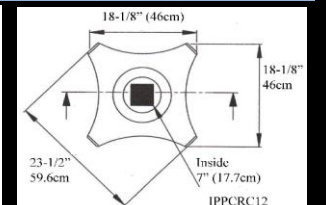





IPPC0808S-ABRC	Load Bearing 99-1/2"		
FRP-PolyComp™	List	Each	50 +
Whole	789.25	591.94	473.55
Split for Post Wrap	876.37	657.28	525.82
Whole Painted White	1013.47	760.11	608.08
Split Painted White	1100.64	825.48	660.38
Split Wraps Round Steel Post 3-1/2"			

ITEM 8-1



Total Height IPPC0808S-ABRC
99-1/2" (253cm)

Load Bearing to
10,000lbs (4.5359 mtons)

Top of Shaft
O/D 6-1/8" (15.5cm)
I/D 5-3/8" (13.65cm)

Bottom of Shaft
O/D 7-5/8" (19.36cm)

Attic Base - Hollow
Height 4-5/8" (11.74cm)

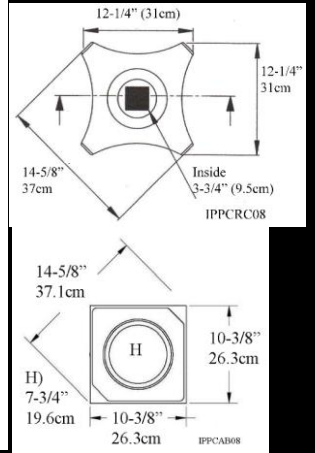

Brochure/Order Form

Custom RomanCorinthian



IPPC0810S-ABRC	Load Bearing 102"		
FRP-PolyComp™	List	Each	50 +
Whole	1095.29	821.47	657.18
Split for Post Wrap	1216.67	912.50	730.00
Whole Painted White	1398.85	1049.14	839.31
Split Painted White	1520.20	1140.15	912.12
Split Wraps 4x4PT, Round Steel Post 4 to 5-1/2"			

ITEM 8-2



Total Height IPPC0810S-ABRC
102" (259cm)

Load Bearing to
14,000 lbs (6.35 mtons)

Top of Shaft
O/D 8" (20.3cm)
I/D 7-1/4" (18.4 cm)

Bottom of Shaft
O/D 9-5/8" (24.4 cm)

Attic Base - Hollow
Height 5-5/8" (14.28cm)

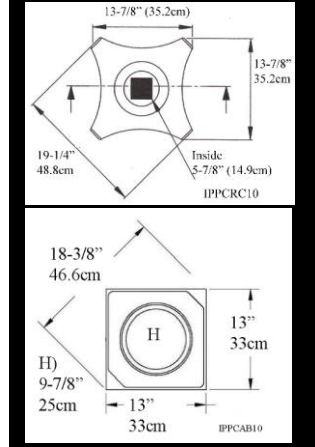

Brochure/Order Form

Custom RomanCorinthian



IPPC0812S-ABRC	Load Bearing 103"		
FRP-PolyComp™	List	Each	50 +
Whole	1458.69	1094.02	875.21
Split for Post Wrap	1561.43	1171.07	936.86
Whole Painted White	1864.08	1398.06	1118.45
Split Painted White	1966.80	1475.10	1180.08
Split Wraps 4x4PT, Round Steel Post 4 to 6-1/2"			

ITEM 8-3



Total Height IPPC0812S-ABRC
103" (261.6cm)

Load Bearing to
14,000 lbs (6.35 mtons)

Top of Shaft
O/D 9-3/8" (23.8cm)
I/D 8-5/8" (21.9cm)

Bottom of Shaft
O/D 11-1/2" (29.2cm)

Attic Base - Hollow
Height 6-3/8" (16.1cm)

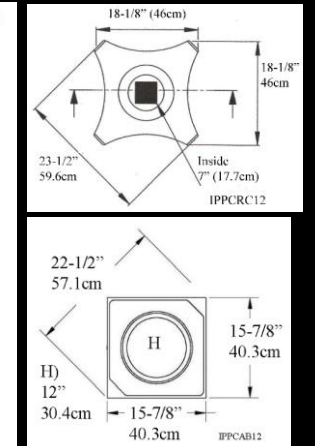

Brochure/Order Form

Custom RomanCorinthian



IPPC0814S-ABRC	Load Bearing 105-3/8"		
FRP-PolyComp™	List	Each	6 +
Whole	2479.74	1859.78	1487.82
Split for Post Wrap	2593.32	1944.99	1555.99
Whole Painted White	2955.57	2216.68	1773.34
Split Painted White	3069.20	2301.90	1841.52
Split Wraps 6x6PT, Steel Post Sq 6x6"			

ITEM 8-4



Total Height IPPC0814S-ABRC
105-3/8" (267.65cm)

Load Bearing to
20,000 lbs (9.07 mtons)

Top of Shaft
O/D 12" (30.48cm)
I/D 11-1/4" (28.57cm)

Bottom of Shaft
O/D 13-7/8" (35.24cm)

Attic Base - Hollow
Height 8-3/8" (21.27cm)

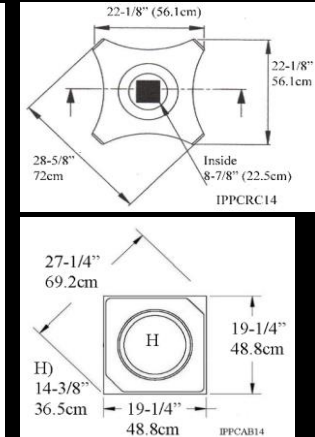

Brochure/Order Form

Custom RomanCorinthian





IPPC0816S-ABRC	Load Bearing 104-3/4"			ITEM 8-5
FRP-PolyComp™	List	Each	6 +	
Whole	2746.46	2059.84	1647.87	
Split for Post Wrap	3710.96	2783.22	2226.58	
Whole Painted White	3961.74	2971.30	2377.04	
Split Painted White	4266.24	3199.68	2559.74	
Split Wraps 6x6PT, Steel Post Sq 6x6"				

Brochure/Order Form

Custom RomanCorinthian



Total Height IPPC0816S-ABRC
104-3/4" (266cm)

Load Bearing to
20,000lbs (9.017mtons)

Top of Shaft
O/D 13-3/4" (34.9cm)
I/D 12-3/4" (32.38cm)

Bottom of Shaft
O/D 15-3/4" (40cm)

Attic Base - Hollow
Height 8-3/4" (22.2cm)

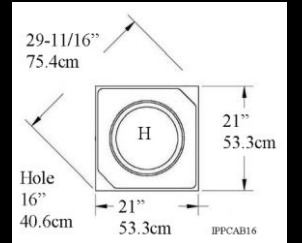
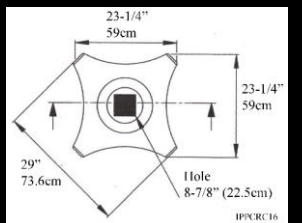

IPPC0818S-ABRC	Load Bearing 104-3/4"			ITEM 8-6
FRP-PolyComp™	List	Each	6 +	
Whole	5562.46	4171.84	3337.47	
Split for Post Wrap	5942.71	4457.03	3565.62	
Whole Painted White	6198.92	4649.19	3719.35	
Split Painted White	6579.19	4934.39	3947.51	
Split Wraps 6x6PT, Steel Post Sq 6x6"				

Brochure/Order Form

Custom RomanCorinthian



Total Height IPPC0818S-ABRC
104-1/4"
268.74cm

Load Bearing to
20,000lbs (9.017mtons)

Top of Shaft
O/D 15-3/8" (39cm)
I/D 14-3/8" (36.5cm)

Bottom of Shaft
O/D 17-1/4" (43.8cm)

Attic Base - Hollow
Height 10-1/4" (26cm)

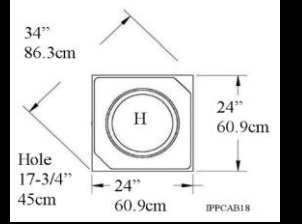
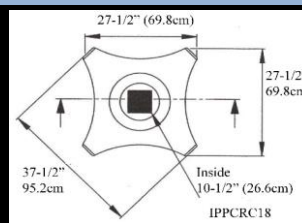

IPPC0908S-ABRC	Load Bearing 111-1/2"			ITEM 9-1
FRP-PolyComp™	List	Each	6 +	
Whole	824.14	618.10	494.48	
Split for Post Wrap	919.60	689.70	551.76	
Whole Painted White	1074.34	805.75	644.60	
Split Painted White	1169.80	877.35	701.88	
Split Wraps Round Steel Post 3-1/2"				

Brochure/Order Form

Custom RomanCorinthian



Total Height IPPC0908S-ABRC
111-1/2" (283cm)

Load Bearing to
10,000lbs (4.5359 mtons)

Top of Shaft
O/D 6-1/8" (15.5cm)
I/D 5-3/8" (13.65cm)

Bottom of Shaft
O/D 7-5/8" (19.36cm)

Attic Base - Hollow
Height 4-5/8" (11.74cm)

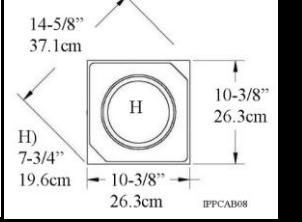
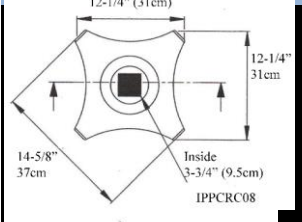

IPPC0910S-ABRC	Load Bearing 114"			ITEM 9-2
FRP-PolyComp™	List	Each	50 +	
Whole	1136.50	852.37	681.90	
Split for Post Wrap	1249.82	937.37	749.89	
Whole Painted White	1467.88	1100.91	880.73	
Split Painted White	1581.24	1185.90	948.72	
Split Wraps 4x4PT, Round Steel Post 4 to 5-1/2"				

Brochure/Order Form

Custom RomanCorinthian



Total Height IPPC0910S-ABRC
114" (289cm)

Load Bearing to
14,000 lbs (6.35 mtons)

Top of Shaft
O/D 8" (20.3cm)
I/D 7-1/4" (18.4 cm)

Bottom of Shaft
O/D 9-5/8" (24.4 cm)

Attic Base - Hollow
Height 5-5/8" (14.28cm)

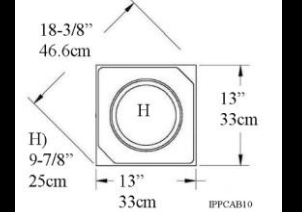
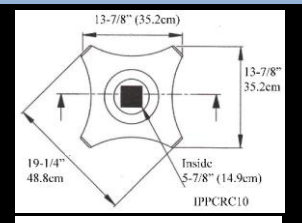

Imperial Productions & Distribution Inc. email: sales@imperialproductions.com



Order Form

SEP-21

555 Riverwalk Parkway Tonawanda NY 14150

IPPC0912S-ABRC	Load Bearing 9 Feet 7"		
FRP-PolyComp™	List	Each	6 +
Whole	1507.84	1130.86	904.69
Split for Post Wrap	1624.74	1218.56	974.85
Whole Painted White	1936.88	1452.66	1162.13
Split Painted White	2053.84	1540.36	1232.29
Split Wraps 4x4PT, Round Steel Post 4 to 6-1/2"			

ITEM 9-3



Total Height IPPC0912S-ABRC
115" (292cm)
Load Bearing to
18,000 lbs (8.16 mtons)
Top of Shaft
O/D 9-1/2" (24.13cm)
I/D 8-3/4" (22.2cm)
Bottom of Shaft
O/D 11-1/2" (29.2cm)
Attic Base - Hollow
Height 12" (30.4cm)

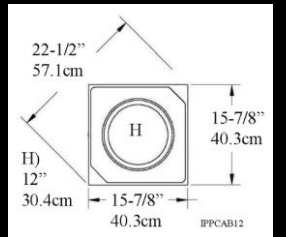
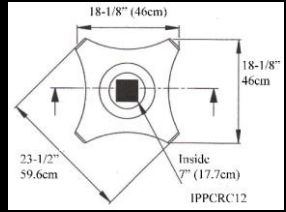

Brochure/Order Form

Custom RomanCorinthian



IPPC0914S-ABRC	Load Bearing 9 Feet 9-3/8"		
FRP-PolyComp™	List	Each	6 +
Whole	2526.22	1894.66	1515.73
Split for Post Wrap	2648.29	1986.22	1588.98
Whole Painted White	3044.29	2283.22	1826.58
Split Painted White	3166.39	2374.80	1899.84
Split Wraps 4x4PT, Round Steel Post 4 to 6-1/2"			

ITEM 9-4



Total Height IPPC0914S-ABRC
117-3/8" (298cm)
Load Bearing to
20,000 lbs (9.07 mtons)
Top of Shaft
O/D 12" (30.48cm)
I/D 11-1/4" (28.57cm)
Bottom of Shaft
O/D 13-7/8" (35.24cm)
Attic Base - Hollow
Height 8-3/8" (21.27cm)

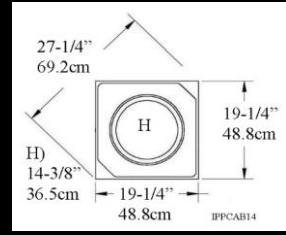
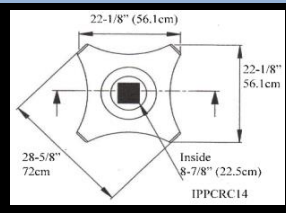

Brochure/Order Form

Custom RomanCorinthian



IPPC0916S-ABRC	Load Bearing 9 Ft- 8-3/8"		
FRP-PolyComp™	List	Each	6 +
Whole	2889.84	2167.36	1733.89
Split for Post Wrap	3861.84	2896.38	2317.10
Whole Painted White	4153.27	3114.95	2491.96
Split Painted White	4465.27	3348.96	2679.16
Split Wraps 6x6PT, Steel Post Sq 6x6"			

ITEM 9-5



Total Height IPPC0916S-ABRC
116-3/4" (296cm)
Load Bearing to
20,000lbs (9.017mtons)
Top of Shaft
O/D 13-3/4" (34.9cm)
I/D 12-3/4" (32.38cm)
Bottom of Shaft
O/D 15-3/4" (40cm)
Attic Base - Hollow
Height 8-3/4" (22.2cm)

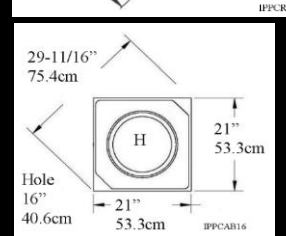
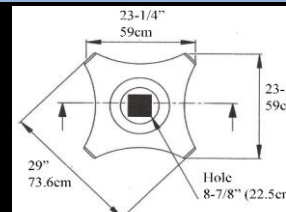

Brochure/Order Form

Custom RomanCorinthian



IPPC0918S-ABRC	Load Bearing 116"		
FRP-PolyComp™	List	Each	6 +
Whole	5659.24	4244.43	3395.54
Split for Post Wrap	6046.90	4535.17	3628.14
Whole Painted White	6349.88	4762.41	3809.93
Split Painted White	6737.79	5053.34	4042.67
Split Wraps 6x6PT, Steel Post Sq 6x6"			

ITEM 9-6



Total Height IPPC0918S-ABRC
116"
296cm
Load Bearing to
20,000lbs (9.017mtons)
Top of Shaft
O/D 15-3/8" (39cm)
I/D 14-3/8" (36.5cm)
Bottom of Shaft
O/D 17-1/4" (43.8cm)
Attic Base - Hollow

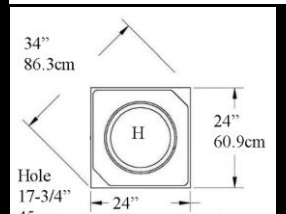
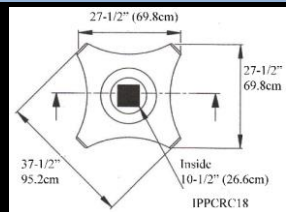

Brochure/Order Form

Custom RomanCorinthian



Height 10-1/4" (26cm)

45cm

60.9cm

IFPCAB18

* All prices & specifications subject to change without notice - All Prices FOB Factory

copyright Imperial Productions®

PAGE RC5



IPPC1008S-ABRC	Load Bearing 10FT 3-1/2"		
FRP-PolyComp™	List	Each	6 +
Whole	847.88	635.91	508.73
Split for Post Wrap	952.23	714.17	571.34
Whole Painted White	1116.04	837.03	669.62
Split Painted White	1220.43	915.32	732.26
Split Wraps Round Steel Post 3-1/2"			

ITEM 10-1



Total Height IPPC1008S-ABRC
123-1/2" (314cm)

Load Bearing to
10,000lbs (4.5359 mtons)

Top of Shaft
O/D 6-1/8" (15.5cm)
I/D 5-3/8" (13.65cm)

Bottom of Shaft
O/D 7-5/8" (19.36cm)

Attic Base - Hollow
Height 4-5/8" (11.74cm)

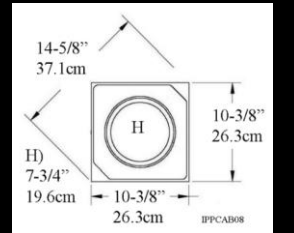
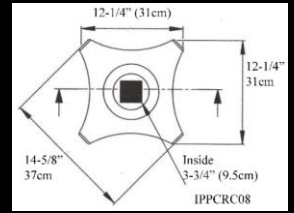

Brochure/Order Form

Custom RomanCorinthian



IPPC01010S-ABRC	Load Bearing 126"		
FRP-PolyComp™	List	Each	50 +
Whole	1174.54	880.89	704.71
Split for Post Wrap	1297.58	973.19	778.55
Whole Painted White	1533.75	1150.31	920.25
Split Painted White	1656.80	1242.60	994.08
Split Wraps 4x4PT, Round Steel Post 4 to 5-1/2"			

ITEM 10-2



Total Height IPPC01010S-ABRC
126" (320cm)

Load Bearing to
14,000 lbs (6.35 mtons)

Top of Shaft
O/D 8" (20.3cm)
I/D 7-1/4" (18.4 cm)

Bottom of Shaft
O/D 9-5/8" (24.4 cm)

Attic Base - Hollow
Height 5-5/8" (14.28cm)

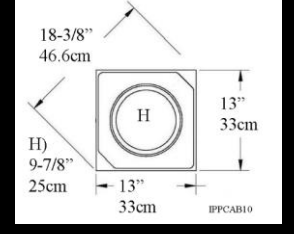
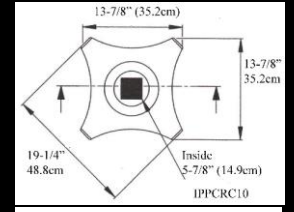

Brochure/Order Form

Custom RomanCorinthian



IPPC1012S-ABRC	Load Bearing 127"		
FRP-PolyComp™	List	Each	6 +
Whole	1558.48	1168.86	935.09
Split for Post Wrap	1685.22	1263.92	1011.13
Whole Painted White	2035.22	1526.42	1221.13
Split Painted White	2161.92	1621.44	1297.15
Split Wraps 4x4PT, Round Steel Post 4 to 6-1/2"			

ITEM 10-3



Total Height IPPC1012S-ABRC
127" (322.5cm)

Load Bearing to
18,000 lbs (8.16 mtons)

Top of Shaft
O/D 9-1/2" (24.13cm)
I/D 8-3/4" (22.2cm)

Bottom of Shaft
O/D 11-1/2" (29.2cm)

Attic Base - Hollow
Height 6-3/8" (16.1cm)

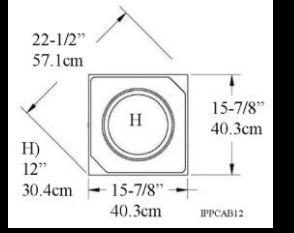
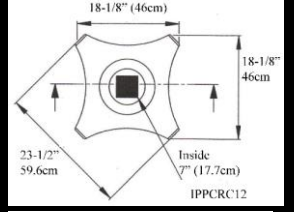

Brochure/Order Form

Custom RomanCorinthian



IPPC1014S-ABRC	Load Bearing 10 Feet 9-3/8"		
FRP-PolyComp™	List	Each	6 +
Whole	2574.77	1931.08	1544.86
Split for Post Wrap	2705.56	2029.17	1623.34
Whole Painted White	3135.07	2351.30	1881.04
Split Painted White	3265.88	2449.41	1959.53
Split Wraps 4x4PT, Round Steel Post 4 to 6-1/2"			

ITEM 10-4



Total Height IPPC1014S-ABRC
129-3/8" (328cm)

Load Bearing to
20,000 lbs (9.07 mtons)

Top of Shaft
O/D 12" (30.48cm)
I/D 11-1/4" (28.57cm)

Bottom of Shaft
O/D 13-7/8" (35.24cm)

Attic Base - Hollow
Height 8-3/8" (21.27cm)

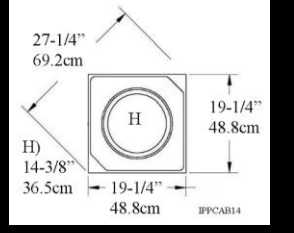
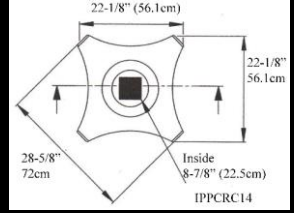

Brochure/Order Form

Custom RomanCorinthian





IPPC1016S-ABRC	Load Bearing 128-3/4"		
FRP-PolyComp™	List	Each	6 +
Whole	3033.18	2274.89	1819.91
Split for Post Wrap	4116.49	3087.36	2469.89
Whole Painted White	4344.85	3258.63	2606.91
Split Painted White	4768.15	3576.11	2860.89
Split Wraps 6x6PT, Steel Post Sq 6x6"			

ITEM 10-5



Total Height IPPC1016S-ABRC
128-3/4" (327cm)

Load Bearing to
20,000lbs (9.017mtons)

Top of Shaft
O/D 13-3/4" (34.9cm)
I/D 12-3/4" (32.38cm)

Bottom of Shaft
O/D 15-3/4" (40cm)

Attic Base - Hollow
Height 8-3/4" (22.2cm)

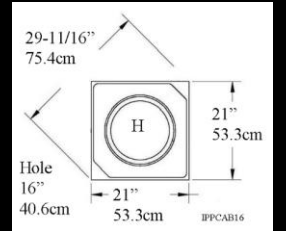
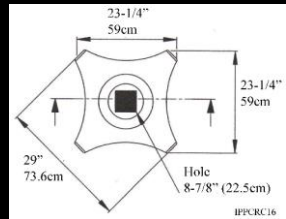

Brochure/Order Form

Custom RomanCorinthian



IPPC1018S-ABRC	Load Bearing 10 Feet 8"		
FRP-PolyComp™	List	Each	6 +
Whole	5755.97	4316.98	3453.58
Split for Post Wrap	6153.40	4615.05	3692.04
Whole Painted White	6500.82	4875.62	3900.49
Split Painted White	6898.28	5173.71	4138.97
Split Wraps 6x6PT, Steel Post Sq 6x6"			

ITEM 10-6



Total Height IPPC1018S-ABRC
128"
326cm

Load Bearing to
20,000lbs (9.017mtons)

Top of Shaft
O/D 15-3/8" (39cm)
I/D 14-3/8" (36.5cm)

Bottom of Shaft
O/D 17-1/4" (43.8cm)

Attic Base - Hollow
Height 10-1/4" (26cm)

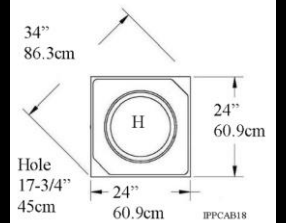
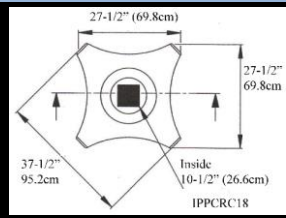

Brochure/Order Form

Custom RomanCorinthian

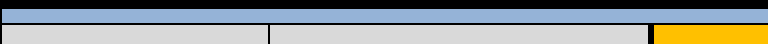

24 HARDWOODS (Hollow with Load Options)

Hardwoods are a Green Choice

Exterior Woods: Pine, Western Red Cedar, White Oak

Interior Woods:

Poplar, Bass, Red Oak, Maple, SapMaple, Ash
Cherry, African Mahogany, Walnut, Yellow Birch

Benefits

Total Customization to the Micro Inch
Solid Capitals and Bases



[Watch Youtube Video](#)

PolyComp & FiberComp™ (Load Bearing)

FiberComp™ is made from 75% calcium carbonate

25% Fiberglass Resins

Capitals & Bases EconPolymer™ - not primed

All Whole Columns are Load Bearing

Always consult with your structural engineer for application

Benefits

Insect, Rot and Water Resistant

Minimal Thermal Transfer to avoid spider cracks

Optional Split for Post Wrap, Cut to Height or Corner Cuts



[Watch Youtube Video](#)

ArchPolymer™ a Decorative Faux Wood

ArchPolymer™ is high density Polyurethane

Lite weight - easy to cut and install for post wrap

Perfect for Theatres, Store Fixtures, Gardens

Not Load Bearing

Benefits

Insect, Rot and Water Resistant

Minimal Thermal Transfer to avoid spider cracks



[Watch Youtube Video](#)

StoneMold™ & Zeament™ Décor Post Wrap

Architectural Artificial Stone Composite Interior Use only

made from Alpha Gypsum Cement with pigment

Not Load Bearing

Columns split with a reveal at the seam

SM: 12 Finishes

ZM: 11 Finishes



[Watch Youtube Video](#)

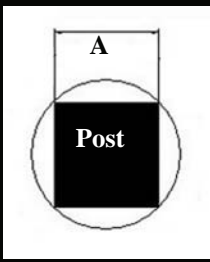

Post Wrap Chart

4 x 4 Square Wood Dressed

Dressed to 3-1/2" x 3-1/2" (8.8 x 8.8cm)

A) Inside Minimum Top of Shaft 5" (12.7cm)

6 x 6 Square Wood Dressed

Dressed 5-1/2" x 5-1/2" (13.9 x 13.9cm)

A) Minimum Inside Top of Shaft
7-3/4" (19.68cm)

4 x 4 Square Steel Post

A) Inside Minimum Top of Shaft
5-3/4" (14.6cm)

6 x 6 Square Steel Post

A) Inside Minimum Inside Top of Shaft
8-5/8" (21.9cm)

8 x 8 Square Wood Dressed

Dressed 7-1/2" x 7-1/2" (19 x 19cm)

A) Inside Minimum 11-1/2" (29.21cm)



Do not measure too tight as you need to take into account manufacturing tolerances that can be up to 1/4" (.63cm) minimum Dressed sizes as per AWC Properties of Structural Lumber S4S (www.AWC.org)

We Sell Steel Posts Galvanized or Primed

Specify Heights, Round or Square Top & Bottom Plates

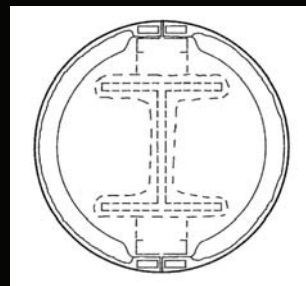

Post Wrap:

- * Pressure Treated Wood Posts 4x4, 6x6
- * I-Beams
- * Round Metal
- * Square Metal

Design Tip:

Consider a post wrap. This gets the framing inspection complete then follow up with the decorative finished column cover once the inspector signs off.



Imperial Productions®

1-800-399-7585

Imperial Productions & Distribution Inc Toronto / New York

email sales@imperialproductions.com copyright 2016 MRDCI All Rights Reserved

FG-TUS-NTAP
JUL-2021



Imperial Productions® Request for Quote

Download, Fill-in & Email to sales@imperialproductions.com

Name / Company: _____

Phone _____ Email _____

Billing Address: _____

City: _____ Prov / State _____

PC / Zip Code _____

Ship to Address: _____

City: _____ Prov / State _____

PC / Zip Code _____

Product Code: _____

Quantity: _____

Notes: _____



Imperial Productions®

1-800-399-7585

Imperial Productions & Distribution Inc Toronto / New York

email sales@imperialproductions.com copyright 2016 MRDCI All Rights Reserved