



Imperial Productions®



Scamozzi Capitals

Load Bearing and Decorative



Scamozzi is a classical style based on the Ionic Order. In simple terms it is an Ionic capital with 4 scrolls or volutes. The style was created by architect Vincenzo Scamozzi in the 16th century. Composite capitals are made from molds.

Hardwood Solid, ArchPolymer - Hollow Shaft goes inside
PolyComp are load bearing and sit on top of the shaft



SPLIT OPTIONS



Order Form

OCT-21

IPCPSCA4		Solid Bottom Ring 4-1/2"		
Interior Hardwood	List	Each	50 +	
Hard Maple	78.12	58.59	46.87	
Red Oak	107.85	80.89	64.71	
Alder	107.85	80.89	64.71	
Cherry	125.92	94.44	75.55	
Walnut	174.98	131.23	104.99	
White Oak	115.31	86.48	69.19	
ArchPolymer™				
ArchPolymer	Custom Priced			
GRG-NeoPlaster	Custom Scamozzi Form			

ITEM 1

[click for Drawing/Order Form](#)

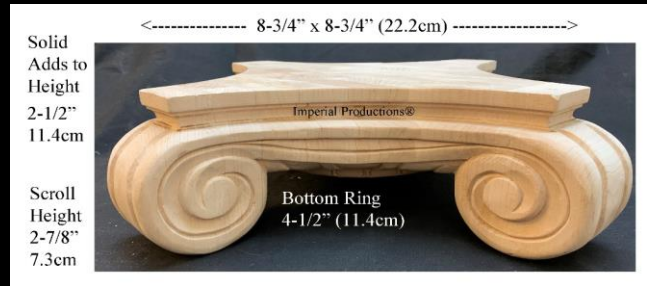

IPCPSCA5		Solid Bottom Ring 5-5/8"		
Interior Hardwood	List	Each	50 +	
Hard Maple	402.18	76.63	61.31	
Red Oak	402.18	76.63	61.31	
Alder	402.18	76.63	61.31	
Cherry	435.96	101.97	81.58	
Walnut	481.24	135.93	108.74	
White Oak	110.96	83.22	66.58	
ArchPolymer™				
ArchPolymer™ Composite	Custom Priced			
GRG-NeoPlaster	Custom Scamozzi Form			

ITEM 2

[click for Drawing/Order Form](#)



IPSCA298-Décor		Fits 6" Column		
ArchPolymer™	List	Each	50 +	
ArchPolymer™ Composite	133.63	100.23	80.18	
Plaster	183.13	137.35	109.88	

ITEM 3

[click for Drawing/Order Form](#)

Custom Scamozzi Form

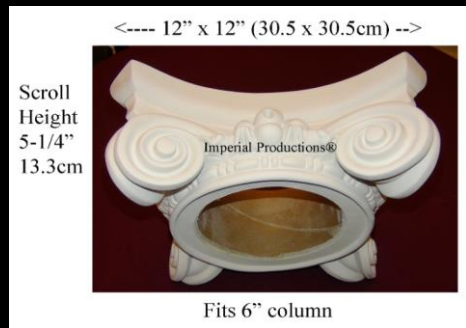

IPSCA100-Décor		O/D Bottom Ring 7-1/4"		
ArchPolymer™	List	Each	50 +	
Whole (Primed White)	119.90	89.93	71.94	
Factory Spray Painted	Custom Priced Specify RAL#			
GRG-NeoPlaster™	Custom Priced			

ITEM 4

[click for Drawing/Order Form](#)

Custom Scamozzi Form

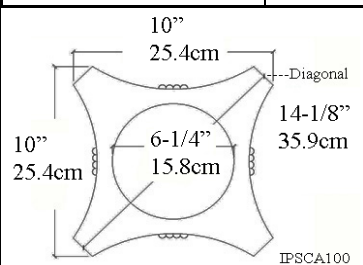



IPSCA299-Décor	O/D Bottom Ring 7-1/4"		
ArchPolymer™	List	Each	50 +
ArchPolymer™ Composite	153.88	115.41	92.33
Plaster	211.48	158.61	126.89

ITEM 5

[click for](#)

Custom Scamozzi Form

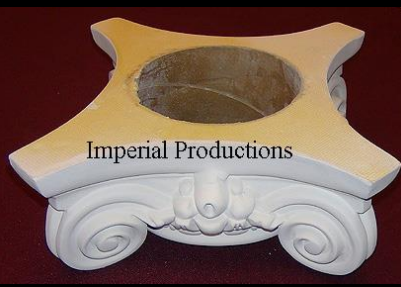
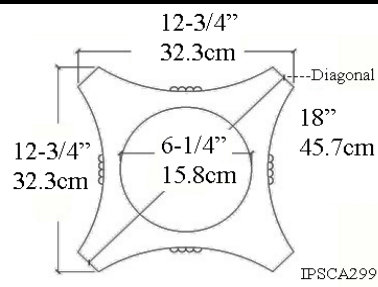

Scroll Height 5-1/4" 13.3cm
Mid Height 4" 10cm



Bottom Ring 7-1/4" (18.4cm)

IPSCA008-Décor	O/D Bottom Ring 6-1/4"		
ECON-POLYMER	List	Each	50 +
Whole	358.35	268.77	215.01
Split for Post Wrap	423.78	317.84	254.27
Split in Half (Pilaster)	423.78	317.84	254.27

ITEM 6

[click for](#)

Custom Scamozzi Form

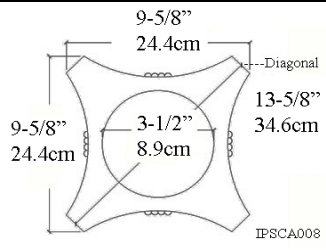

Mid Height 3" 7.6cm



Scroll Height 4-1/4" 10.8cm

O/D Bottom Ring 6-1/4" (15.8cm)

IPPCSC08-Load	O/D Load Ring 6-1/2"		
FRP-PolyComp™	List	Each	50 +
Whole	282.00	211.50	169.20
Whole White Painted	300.08	225.06	180.05
Split in Half (Pilaster)	330.73	248.04	198.44
Split in Half White Painted	348.83	261.62	209.30

ITEM 7

[click for Drawing/Order Form](#)

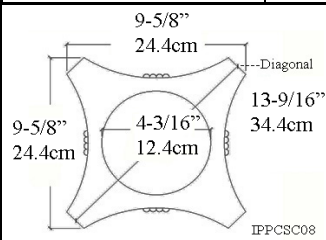

Load Bearing to 10,000 lbs (4.5mtons)



3-1/8" 7.9cm

Round Bottom Ring 6-1/2" (16.5cm)

IPSCA150-Décor	O/D Bottom Ring 7-3/4"		
ArchPolymer™	List	Each	50 +
Whole (Primed White)	125.78	94.33	75.47

ITEM 8

[click for Drawing/Order Form](#)

Custom Scamozzi Form

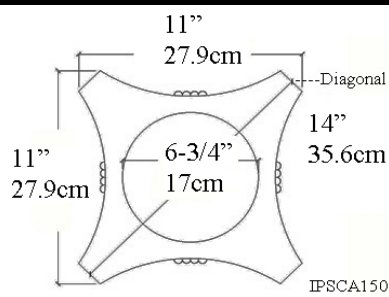

3-1/4" 8.3cm

Scroll Height 4-5/8" 11.7cm

Round Bottom Ring 7-3/4" (19.7cm)



IPSCA151-Décor	O/D Bottom Ring 7-3/4"		
ArchPolymer™	List	Each	50 +
Whole (Primed White)	128.50	96.38	77.10

ITEM 9

[click for Drawing/Order Form](#)

[Custom Scamozzi Form](#)

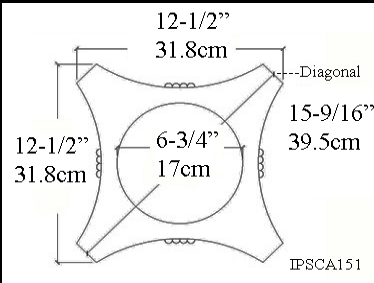

Center Height 3-1/2" 8.9cm



Scroll Height 4-15/16" 12.5cm

Round Bottom Ring 7-3/4" (19.68cm)

IPSCA149-Décor	O/D Bottom Ring 9"		
ArchPolymer™	List	Each	50 +
Whole (Primed White)	154.32	96.38	77.10

ITEM 10

[click for Drawing/Order Form](#)

[Custom Scamozzi Form](#)

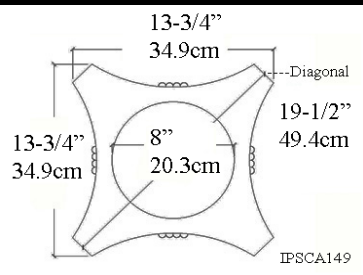

Center Height 4" 10cm



Scroll Height 5-5/8" 14.2cm

Round Bottom Ring 9" (22.8cm)

IPSCA300-Décor	O/D Bottom Ring 9"		
ArchPolymer™	List	Each	50 +
ArchPolymer™ Composite	233.76	175.32	140.26
Plaster	323.31	242.48	193.99

ITEM 11

[click for Drawing/Order Form](#)

[Custom Scamozzi Form](#)

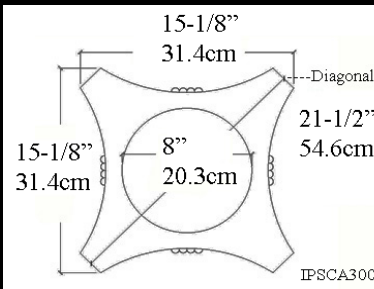

7-1/16" 17.9cm



Mid Height 7-3/8" 18.7cm

12" (30.4cm)

IPSCA103-Décor	O/D Bottom Ring 9-1/4"		
ArchPolymer™	List	Each	50 +
Whole (Primed White)	151.56	113.67	90.94
Factory Spray Painted	Custom Priced Specify RAL#		
GRG-NeoPlaster™	Custom Priced		

ITEM 12

[click for Drawing/Order Form](#)

[Custom Scamozzi Form](#)

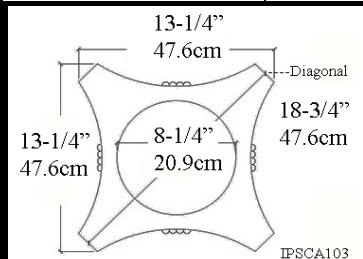

Center Height 4" 10cm



Total Height 5-3/4" 14.6cm

Round Bottom Ring 9-1/4" (23.5cm)

IPPCSC10-Load	O/D Load Ring 8-3/4"		
FRP-PolyComp™	List	Each	50 +
Whole	421.39	316.04	252.83
Whole White Painted	448.98	336.73	269.39
Split in Half (Pilaster)	470.16	352.62	282.10
Split in Half White Painted	497.75	373.31	298.65

ITEM 13

[click for Drawing/Order Form](#)

Load Bearing

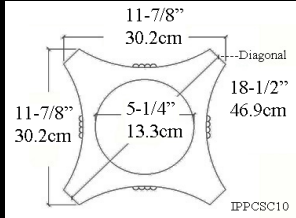

Round Bottom Ring 8-3/4" (22.2cm)

IPSCA010-Décor	O/D Bottom Ring 8-7/8"		
ECON-POLYMER	List	Each	50 +
Whole	508.35	381.26	305.01
Split for Post Wrap	573.77	430.33	344.26
Split in Half (Pilaster)	573.77	430.33	344.26

ITEM 14

[click for Drawing/Order Form](#)

Custom Scamozzi Form

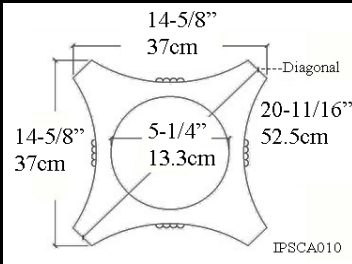

O/D Bottom Ring 8-7/8" (22.5cm)

IPSCA153-Décor	O/D Bottom Ring 10"		
ArchPolymer™	List	Each	50 +
Whole (Primed White)	203.48	152.61	122.09

ITEM 15

[click for Drawing/Order Form](#)

Custom Scamozzi Form

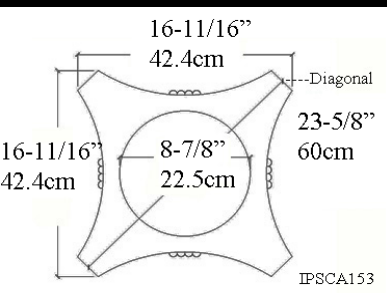

Round Bottom Ring 10" (25.4cm)

IPPCSC12-LOAD	O/D Load Ring 9-3/4"		
FRP-PolyComp™	List	Each	50 +
Whole	592.46	444.35	355.48
Whole White Painted	639.80	479.85	383.88
Split in Half (Pilaster)	641.23	480.93	384.74
Split in Half White Painted	688.58	516.43	413.15

ITEM 16

[click for Drawing/Order Form](#)

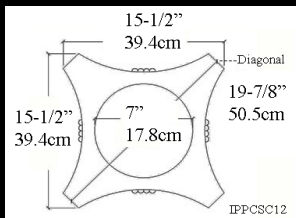

Round Bottom Ring 9-3/4" (24.8cm)



IPMRD9000-Décor	O/D Bottom Ring 11"		
ArchPolymer™	List	Each	50 +
Whole (Primed White)	133.02	99.77	79.81

ITEM 17

[click for Drawing/Order Form](#)

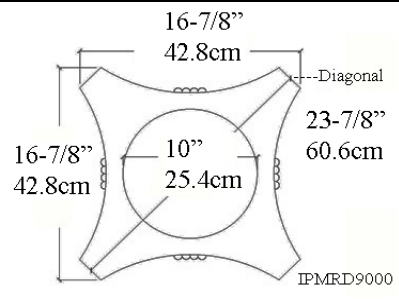

Center Height 5" 12.7cm



Scroll Height 7" 17.7cm

Round Bottom Ring 11" (27.9cm)

IPSCA152-Décor	O/D Bottom Ring 11"		
ArchPolymer™	List	Each	50 +
Whole (Primed White)	169.02	126.76	101.41

ITEM 18

[click for Drawing/Order Form](#)

Custom Scamozzi Form

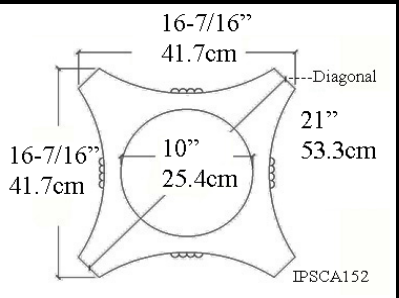

Center Height 4-3/4" 12cm



Scroll Height 6-3/4" 17cm

Round Bottom Ring 11" (27.9cm)

IPPCSC14-LOAD	O/D Load Ring 10-1/4"		
FRP-PolyComp™	List	Each	50 +
Whole	810.50	607.88	486.30
Whole White Painted	862.93	647.20	517.76
Split in Half (Pilaster)	859.85	644.89	515.91
Split in Half White Painted	912.27	684.21	547.36

ITEM 19

[click for Drawing/Order Form](#)

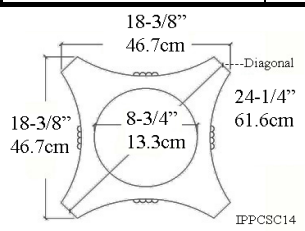

Load Bearing to 18,000 lbs (8.16mtons)

Center Height 5-1/2" 14cm



Scroll Height 7-7/8" 20cm

Round Bottom Ring 10-1/4" (26cm)

IPSCA012-Décor	O/D Bottom Ring 10-1/2"		
ECON-POLYMER	List	Each	50 +
Whole	562.54	421.88	337.50
Split for Post Wrap	627.93	470.95	376.76
Split in Half (Pilaster)	627.93	470.95	376.76

ITEM 20

[click for Drawing/Order Form](#)

Custom Scamozzi Form

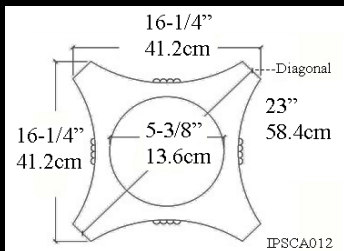

Center Height 5-1/8" 13cm



Scroll Height 7-1/4" 18.4cm

O/D Bottom Ring 10-1/2" (26.7cm)



IPSCA105-Décor	O/D Bottom Ring 11-1/4"		
ArchPolymer™	List	Each	50 +
Whole (Primed White)	308.29	231.22	184.97
Factory Spray Painted	Custom Priced Specify RAL#		
GRG-NeoPlaster™	Custom Priced		

ITEM 21

[click for Drawing/Order Form](#)

[Custom Scamozzi Form](#)

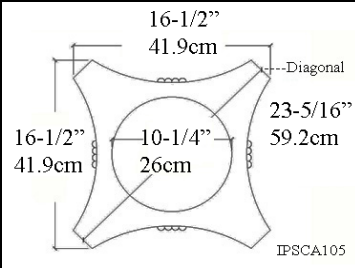

Bottom Ring 11-1/4" (28.6cm)

IPSCA154-Décor	O/D Bottom Ring 11-1/2"		
ArchPolymer™	List	Each	50 +
Whole (Primed White)	288.78	216.58	173.27

ITEM 22

[click for Drawing/Order Form](#)

[Custom Scamozzi Form](#)

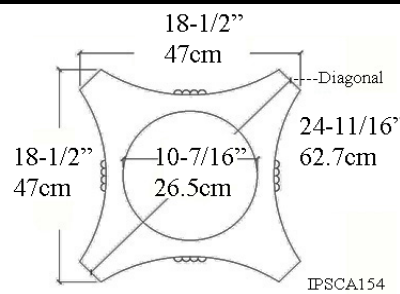

Bottom Ring 11-1/2" (28.6cm)

IPSCA301-Décor	O/D Fits 12"		
ArchPolymer™	List	Each	50 +
ArchPolymer™ Composite	364.88	271.41	217.13
Plaster	494.63	370.97	296.78

ITEM 23

[click for Drawing/Order Form](#)

[Custom Scamozzi Form](#)

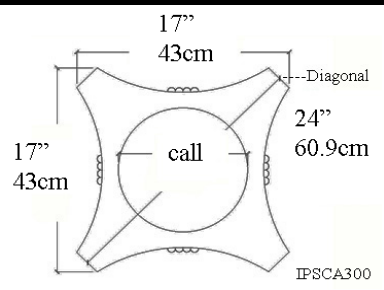

Bottom Ring call

IPSCA014-Décor	O/D Bottom Ring 12-1/4"		
ECON-POLYMER	List	Each	50 +
Whole	878.54	658.88	527.11
Split for Post Wrap	943.94	707.95	566.36
Split in Half (Pilaster)	943.94	707.95	566.36

ITEM 24

[click for Drawing/Order Form](#)

[Custom Scamozzi Form](#)

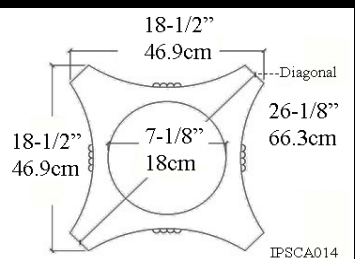

O/D Bottom Ring 12-1/4" (31cm)



IPSCA155-Décor	O/D Bottom Ring 13-1/4"		
ArchPolymer™	List	Each	50 +
Whole (Primed White)	227.80	170.85	136.68

ITEM 25

[click for Drawing/Order Form](#)

[Custom Scamozzi Form](#)

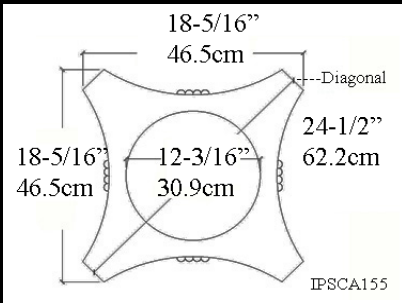

Center Height 5-7/16\"/>



Scroll Height 7-3/4\"/>

Bottom Ring 13-1/4" (33.65cm)

IPSCA106-Décor	O/D Bottom Ring 11-1/4"		
ArchPolymer™	List	Each	50 +
Whole (Primed White)	378.35	283.77	227.01
Factory Spray Painted	Custom Priced Specify RAL#		
GRG-NeoPlaster™	Custom Priced		

ITEM 26

[click for Drawing/Order Form](#)

[Custom Scamozzi Form](#)

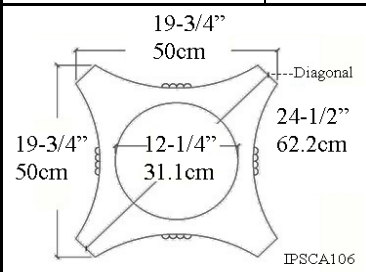

Center Height 6\"/>



Scroll Height 8-1/2\"/>

Bottom Ring 13-1/4" (33.65cm)

IPPCSC14-LOAD	O/D Load Ring 14"		
FRP-PolyComp™	List	Each	50 +
Whole	1403.56	1052.67	842.13
Whole White Painted	1464.06	1098.04	878.43
Split in Half (Pilaster)	1637.59	1228.19	982.56
Split in Half White Painted	1698.09	1273.57	1018.86

ITEM 27

[click for Drawing/Order Form](#)

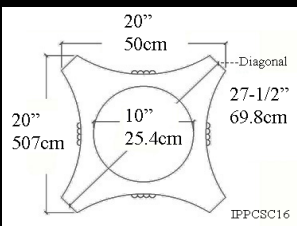

Load Bearing to 18,000 lbs (8.16mtons)

Center Height 6\"/>



Scroll Height 8-1/2\"/>

Round Bottom Ring 14" (35.6cm)

IPSCA107-Décor	O/D Bottom Ring 15-1/4"		
ArchPolymer™	List	Each	50 +
Whole (Primed White)	431.60	323.70	258.96
Factory Spray Painted	Custom Priced Specify RAL#		
GRG-NeoPlaster™	Custom Priced		

ITEM 28

[click for Drawing/Order Form](#)

[Custom Scamozzi Form](#)

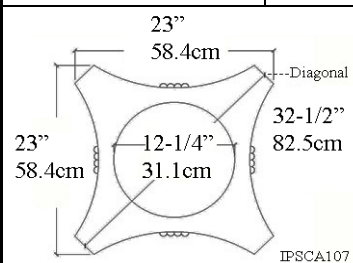

Center Height 7\"/>



Scroll Height 10\"/>

Bottom Ring 15-1/4" (38.7cm)



IPSCA016-Décor	O/D Bottom Ring 12-1/4"		
ECON-POLYMER	List	Each	50 +
Whole	995.92	746.94	597.55
Split for Post Wrap	1223.42	917.57	734.05
Split in Half (Pilaster)	1223.42	917.57	734.05

ITEM 29

[click for Drawing/Order Form](#)

[Custom Scamozzi Form](#)

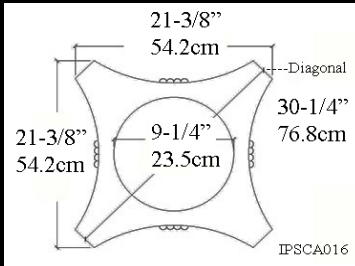

Center Height 5-7/8" 14.9cm



Scroll Height 8-5/8" 21.9cm

O/D Bottom Ring 14-1/4" (36cm)

IPPCSC18-LOAD	O/D Load Ring 15-1/2"		
FRP-PolyComp™	List	Each	50 +
Whole	1725.15	1293.86	1035.09
Whole White Painted	1799.58	1349.68	1079.75
Split in Half (Pilaster)	2026.27	1519.70	1215.76
Split in Half White Painted	2100.71	1575.54	1260.43

ITEM 30

[click for Drawing/Order Form](#)

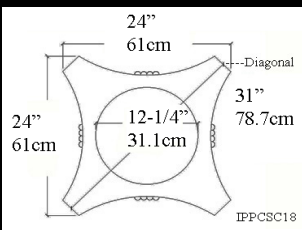

Load Bearing to 18,000 lbs (8.16mtons)

Center Height 7-1/8" 18.1cm



Scroll Height 14-3/4" 37.5cm

Round Bottom Ring 15-1/2" (39.4cm)

IPSCA302-Décor	Fits 16" column		
ArchPolymer™	List	Each	50 +
ArchPolymer™ Composite	682.50	511.88	409.50
Plaster	943.50	707.63	566.10

ITEM 31

[click for Drawing/Order Form](#)

[Custom Scamozzi Form](#)



IPSCA108-Décor	O/D Bottom Ring 17-1/2"		
ArchPolymer™	List	Each	50 +
Whole (Primed White)	462.42	346.82	277.45
Factory Spray Painted	Custom Priced Specify RAL#		
GRG-NeoPlaster™	Custom Priced		

ITEM 32

[click for Drawing/Order Form](#)

[Custom Scamozzi Form](#)

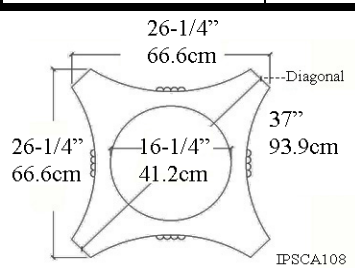

Center Height 8" 20.3cm



Scroll Height 11-1/2" 29.2cm

Bottom Ring 17-1/2" (44.5cm)



IPSCA018-Décor	O/D Bottom Ring 17-1/4"		
ECON-POLYMER	List	Each	50 +
Whole	1472.91	1104.69	883.75
Split for Post Wrap	1700.41	1275.31	1020.25
Split in Half (Pilaster)	1700.41	1275.31	1020.25

ITEM 33

[click for Drawing/Order Form](#)

[Custom Scamozzi Form](#)

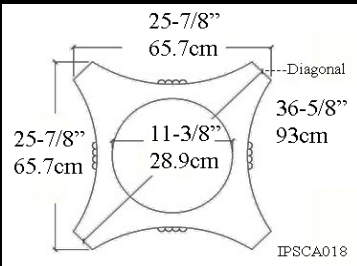

Center Height
7-1/2"
19cm



Scroll Height
10-7/8"
27.6cm

O/D Bottom Ring 17-1/4" (36cm)

IPSCA020-Décor	O/D Bottom Ring 18-5/8"		
ECON-POLYMER	List	Each	50 +
Whole	2168.18	1626.13	1300.91
Split for Post Wrap	2459.20	1844.40	1475.52
Split in Half (Pilaster)	2459.20	1844.40	1475.52

ITEM 34

[click for Drawing/Order Form](#)

[Custom Scamozzi Form](#)

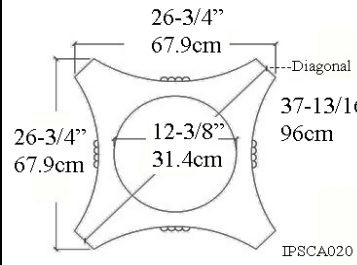

Center Height
8-1/2"
21.5cm



Scroll Height
11"
27.9cm

O/D Bottom Ring 18-5/8" (47.3cm)

IPSCA022-Décor	O/D Bottom Ring 21-1/2"		
ECON-POLYMER	List	Each	50 +
Whole	2695.12	2021.34	1617.07
Split for Post Wrap	2986.14	2239.61	1791.69
Split in Half (Pilaster)	2986.14	2239.61	1791.69

ITEM 35

[click for Drawing/Order Form](#)

[Custom Scamozzi Form](#)

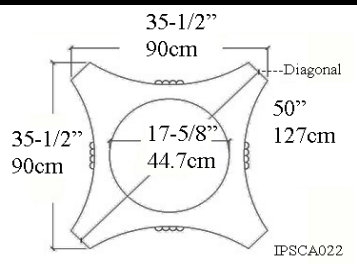

Center Height
11-1/4"
28.5cm



Scroll Height
15-1/4"
38.7cm

O/D Bottom Ring 21-1/2" (54.6cm)

IPSCA024-Décor	O/D Bottom Ring 22-3/4"		
ECON-POLYMER	List	Each	50 +
Whole	3216.09	2412.07	1929.65
Split for Post Wrap	3507.11	2630.34	2104.27
Split in Half (Pilaster)	3507.11	2630.34	2104.27

ITEM 36

[click for Drawing/Order Form](#)

[Custom Scamozzi Form](#)

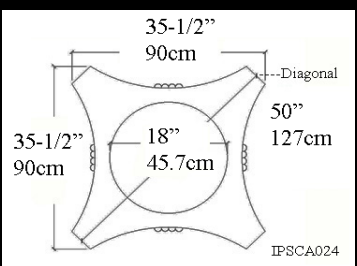

Center Height
11-3/8"
28.9cm



Scroll Height
12-3/4"
32.4cm

O/D Bottom Ring 22-3/4" (57.86cm)



[Order Form](#)

OCT-21

IPSCA030-Décor	O/D Bottom Ring 28"		
ECON-POLYMER	List	Each	50 +
Whole	3785.38	2839.04	2271.23
Split for Post Wrap	3945.55	2959.17	2367.33
Split in Half (Pilaster)	3945.55	2959.17	2367.33

ITEM 37

[click for Drawing/Order Form](#)

[Custom Scamozzi Form](#)

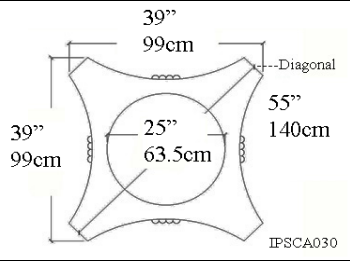

Center Height 15" 38.1cm



Scroll Height 21-1/2" 54.6cm

O/D Bottom Ring 28" (71cm)

IPSCA036-Décor	O/D Bottom Ring 28"		
ECON-POLYMER	List	Each	50 +
Whole	call for pricing		
Split for Post Wrap			
Split in Half (Pilaster)			

ITEM 38

[click for Drawing/Order Form](#)

[Custom Scamozzi Form](#)

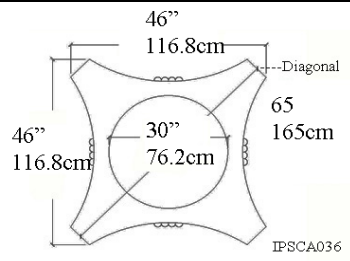

Center Height 15" 38.1cm



Scroll Height 21-1/2" 54.6cm

O/D Bottom Ring 32" (81.28cm)

Need Gold Leaf ?
Imperial has Ronan
Specialty Paints
call for Details





Imperial Productions® Request for Quote

Download, Fill-in & Email to sales@imperialproductions.com

Name / Company: _____

Phone _____ Email _____

Billing Address: _____

City: _____ Prov / State _____

PC / Zip Code _____

Ship to Address: _____

City: _____ Prov / State _____

PC / Zip Code _____

Product Code: _____

Quantity: _____

Notes: _____



Imperial Productions®

1-800-399-7585

Imperial Productions & Distribution Inc Toronto / New York

email sales@imperialproductions.com copyright 2016 MRDCI All Rights Reserved

Material Properties | **HARDWOODS**

Hardwoods are a Green Choice
Sanded to 220 Ready to Paint or Stain
Exterior Woods: Pine, Western Red Cedar, White Oak
Interior Woods:
Poplar, Bass, Red Oak, Maple, SapMaple, Ash
Cherry, African Mahogany, Walnut, Yellow Birch

Benefits
Total Customization to the Micro Inch
Solid Capitals and Bases



[click to Watch Youtube Video](#)

Material Properties | **PolyComp & FiberComp™**

made from 75% calcium carbonate, 25% Fiberglass Resins
FiberComp™ EconPolymer Caps and Bases (not primed)
PolyComp™ EconPolymer Caps (paint option)
All Whole Columns are Load Bearing
Always consult with your structural engineer for application

Benefits
Insect, Rot and Water Resistant
Minimal Thermal Transfer to avoid spider cracks
Optional Split for Post Wrap, Cut to Height or Corner Cuts



[click to Watch Youtube Video](#)

Material Properties | **ArchPolymer™**

ArchPolymer™ is high density Polyurethane
Lite weight - easy to cut and install for post wrap
Perfect for Theatres, Store Fixtures, Gardens
Not Load Bearing
Primed Ready to Paint by others

Benefits
Insect, Rot and Water Resistant
Minimal Thermal Transfer to avoid spider cracks



[click to Watch Youtube Video](#)

Material Properties | **StoneMold™ & Zeament™ Décor Post Wraps**

Architectural Artificial Stone Composite Interior Use only
made from Alpha Gypsum Cement with pigment
Not Load Bearing
Columns split with a reveal at the seam
12 Finishes 11 Finishes



[click to Watch Youtube Video](#)