



Imperial Productions®



Acorn Pediments

with or without Frieze Boards

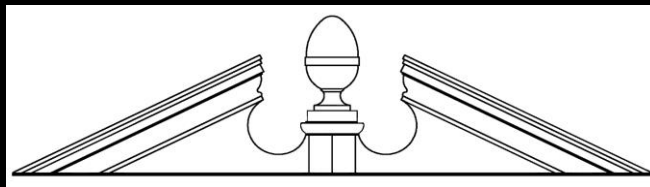
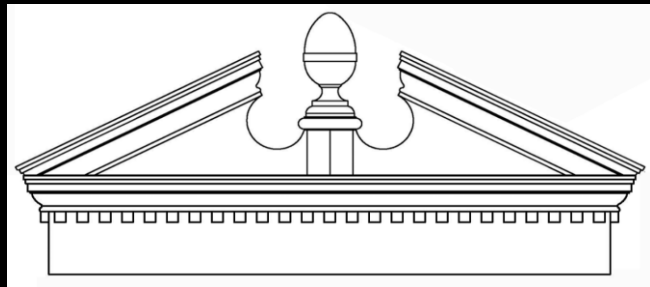
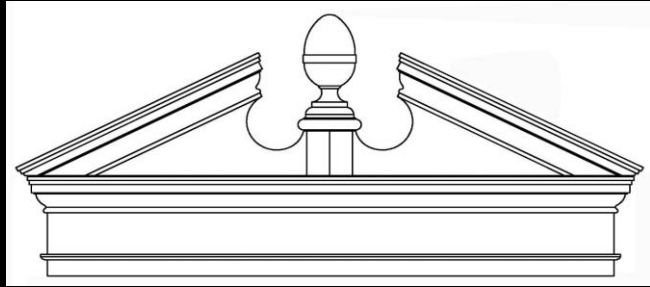

Contact Us

Decorate the Frieze Board with
a Panel Mold or Dentil Strip

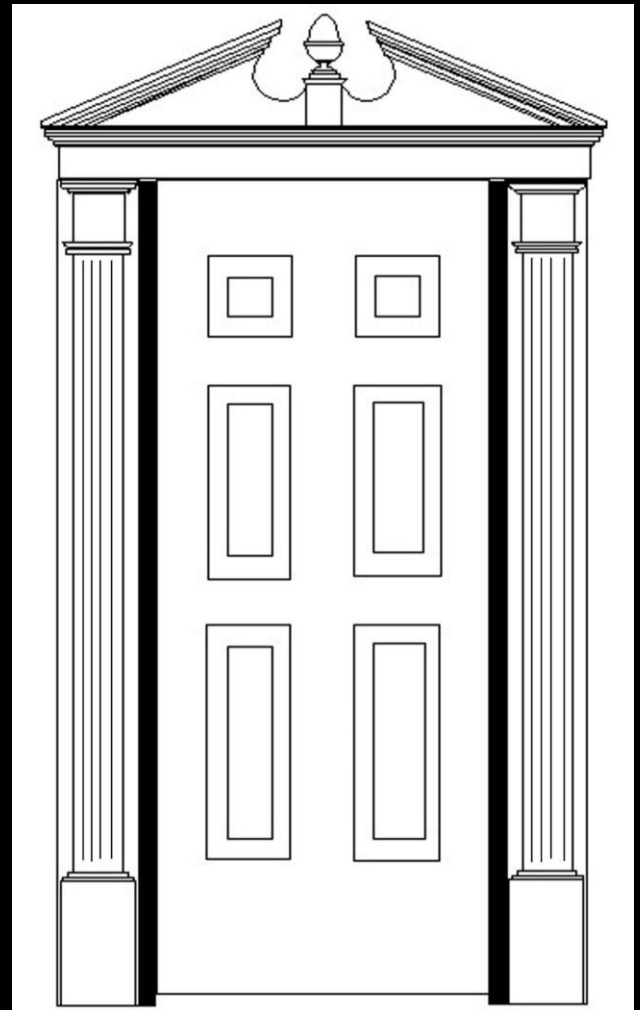

click to Watch Youtube Movie



Design Ideas

How to decorate a Frieze Board

a) Place the Street Name & #

b) click to select a decorative frieze

c) click to select an applique

2 Fluted Pilasters

It is architecturally correct to allow the pilasters to exceed the the horizontal Frieze Board in this drawing the pilasters are mounted on flat backboards

[click for Pilasters on our website](#)

Pilaster Plinths

Acorn

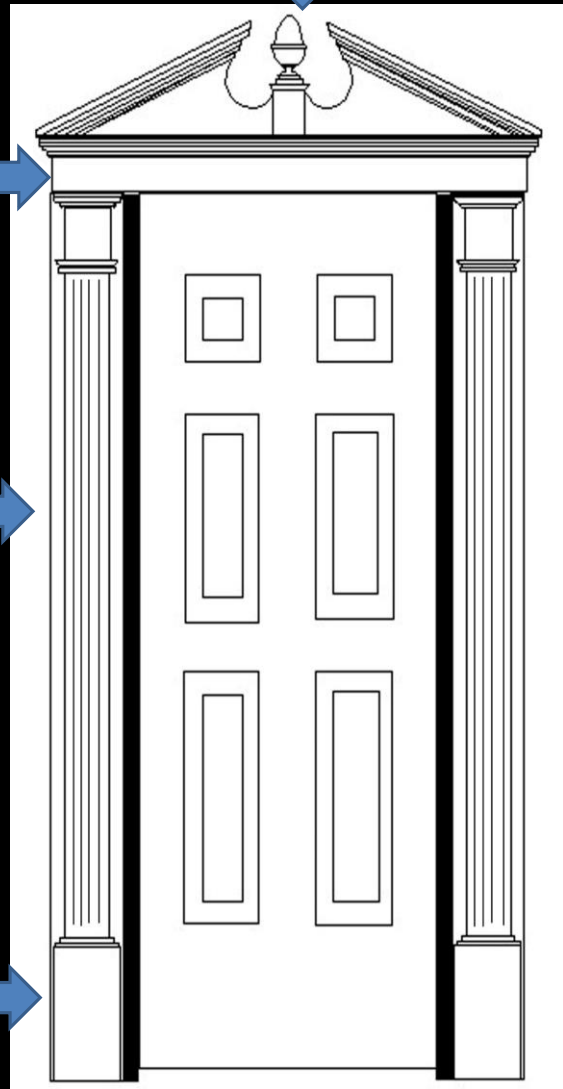

Brickmold

Separates Brick from the Door Casing

[click to no rot Brickmolds](#)

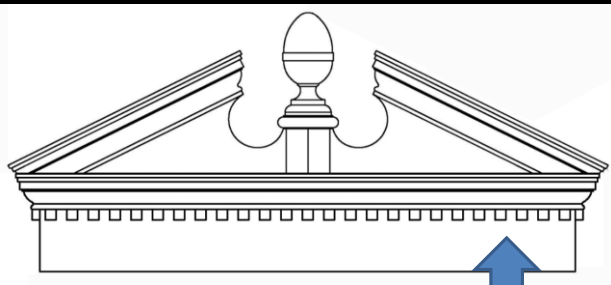

For Federal Style
Add Dentil Trim Strip

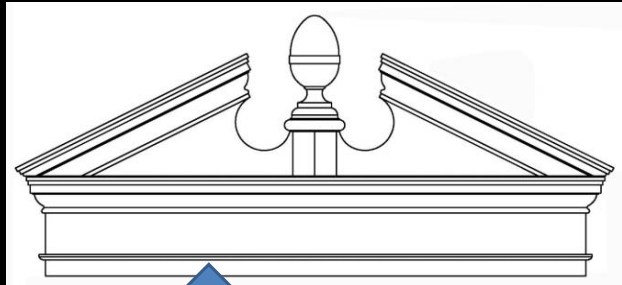

For Colonial Style
Add a Panel Mold



IPPED1900

Brochure/Order Form

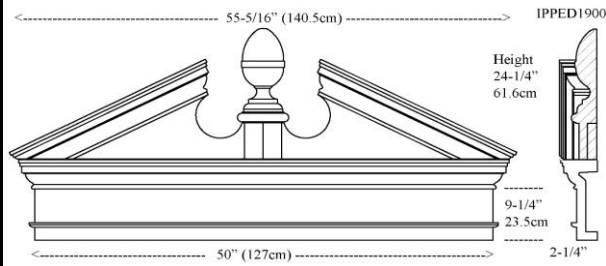

Materials	List	Each	10 +	ITEM 1
ArchPolymer™	336.35	252.26	201.81	

IPPED901

Brochure/Order Form

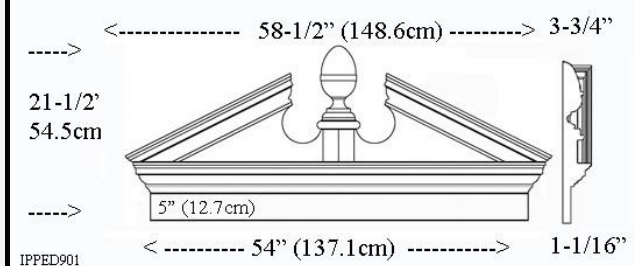

Materials	List	Each	10 +	ITEM 5
ArchPolymer™	319.02	239.26	191.41	

IPPED1901

Brochure/Order Form

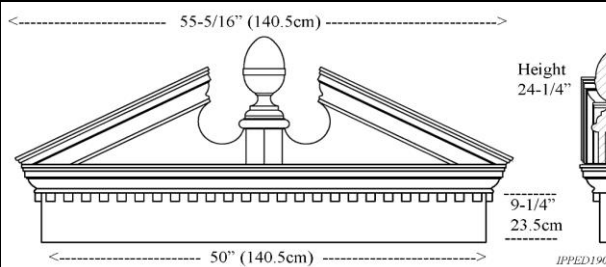

Materials	List	Each	10 +	ITEM 2
ArchPolymer™	338.56	253.92	203.13	

IPPED902

Brochure/Order Form

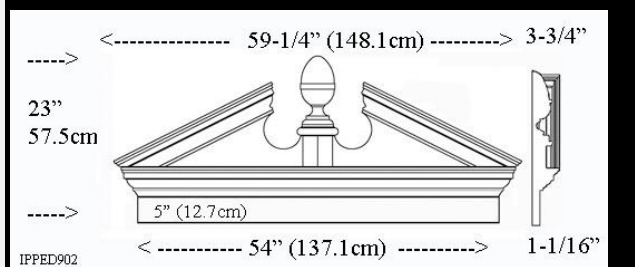

Materials	List	Each	10 +	ITEM 6
ArchPolymer™	314.78	236.08	188.87	

IPPED1904

Brochure/Order Form

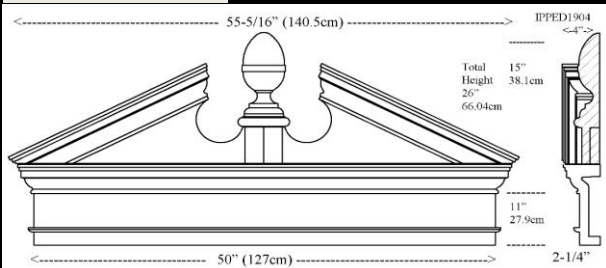

Materials	List	Each	10 +	ITEM 3
ArchPolymer™	381.69	286.27	229.01	

IPPED1902

Brochure/Order Form

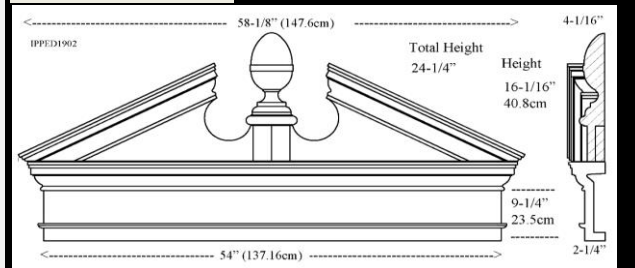

Materials	List	Each	10 +	ITEM 7
ArchPolymer™	377.72	283.29	226.63	

IPPED900

Brochure/Order Form

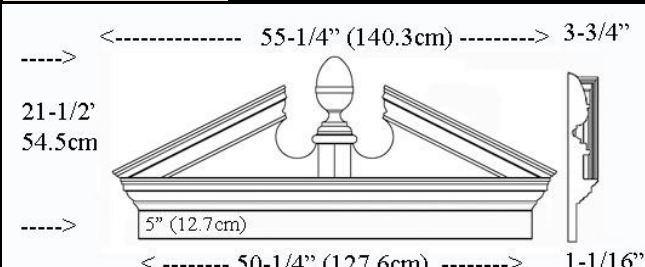

Materials	List	Each	10 +	ITEM 4
ArchPolymer™	302.84	227.10	181.68	

IPPED1903

Brochure/Order Form

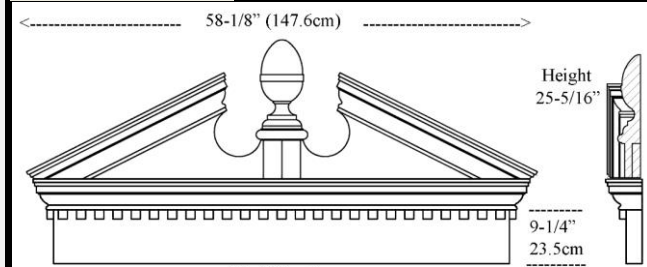

Materials	List	Each	10 +	ITEM 8
ArchPolymer™	377.94	283.46	226.77	



IPPED1905

Brochure/Order Form

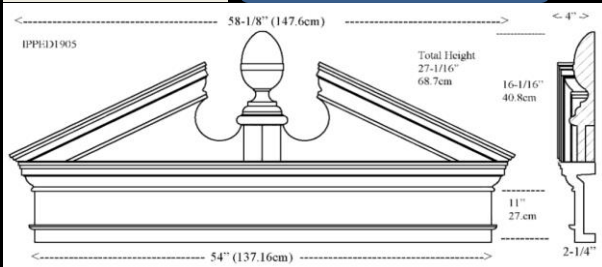

Materials	List	Each	10 +	ITEM 9
ArchPolymer™	392.54	294.38	235.51	

IPPED1908

Brochure/Order Form

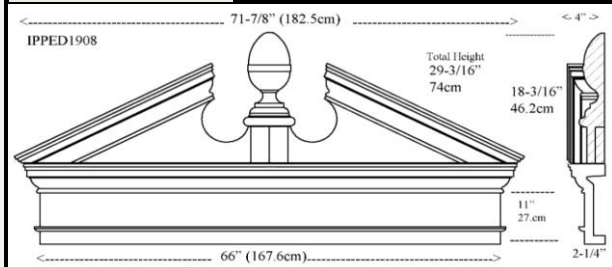

Materials	List	Each	10 +	ITEM 13
ArchPolymer™	523.90	392.93	314.34	

IPPED903

Brochure/Order Form

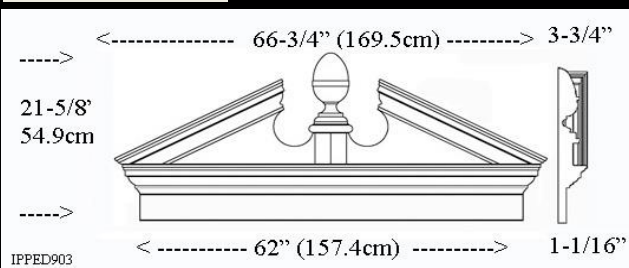

Materials	List	Each	10 +	ITEM 10
ArchPolymer™	403.54	302.65	242.12	

IPPED904

Brochure/Order Form

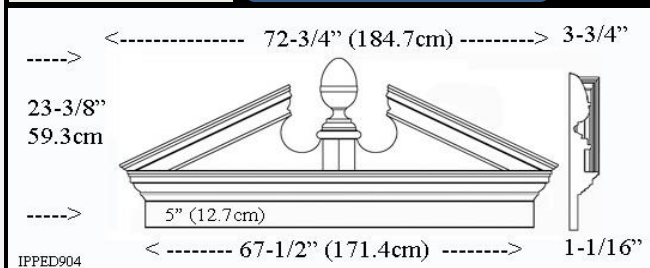

Materials	List	Each	10 +	ITEM 14
ArchPolymer™	396.50	297.37	237.90	

IPPED1906

Brochure/Order Form

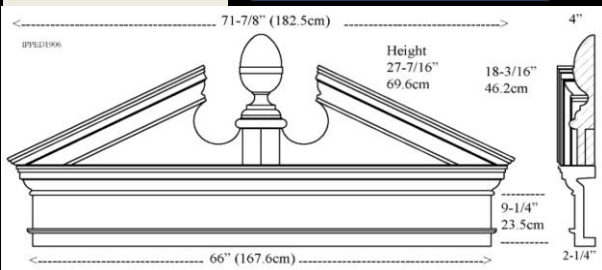

Materials	List	Each	10 +	ITEM 11
ArchPolymer™	523.90	392.93	314.34	

IPPED905

Brochure/Order Form

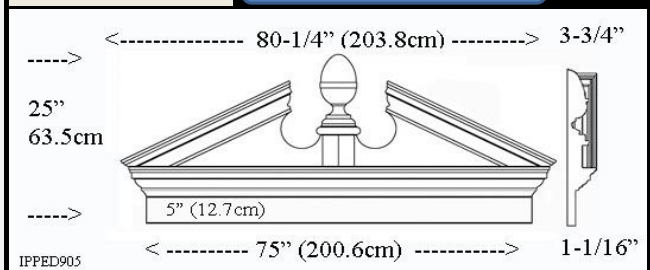

Materials	List	Each	10 +	ITEM 15
ArchPolymer™	456.26	342.19	273.75	

IPPED1907

Brochure/Order Form

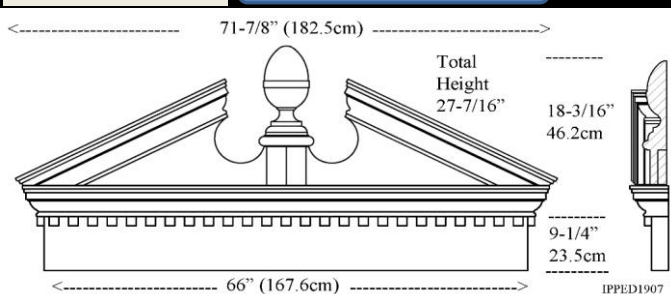

Materials	List	Each	10 +	ITEM 12
ArchPolymer™	523.90	392.93	314.34	

IPPED906

Brochure/Order Form

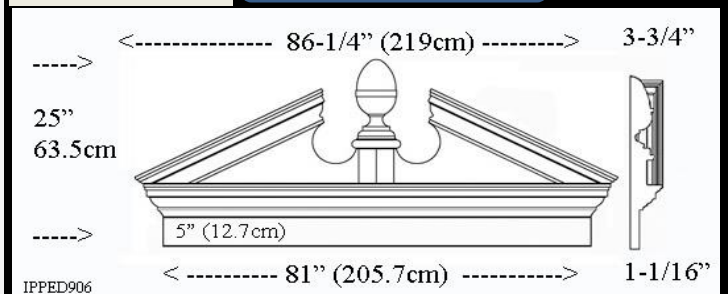

Materials	List	Each	10 +	ITEM 16
ArchPolymer™	484.53	363.39	290.72	



IPPED1909

Brochure/Order Form

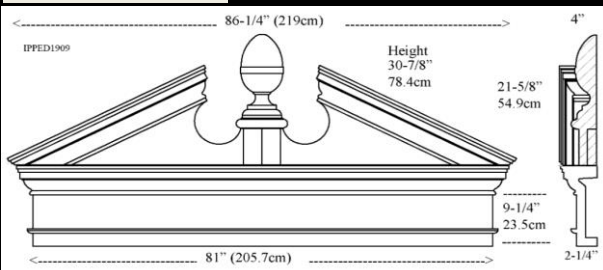

Materials	List	Each	10 +
ArchPolymer™	608.54	456.40	365.12

ITEM 17

IPPED1912

Brochure/Order Form

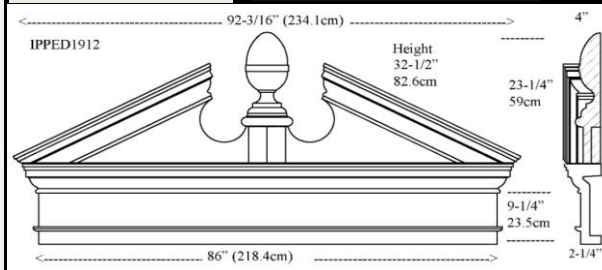

Materials	List	Each	10 +
ArchPolymer™	626.59	469.94	375.95

ITEM 21

IPPED1910

Brochure/Order Form

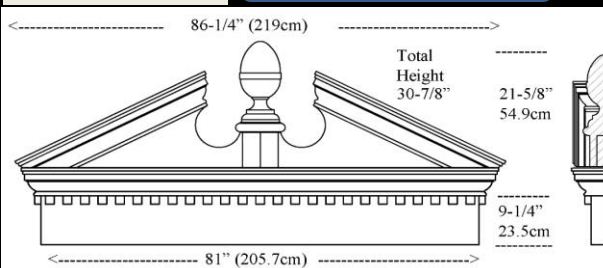

Materials	List	Each	10 +
ArchPolymer™	608.54	456.40	365.12

ITEM 18

IPPED1913

Brochure/Order Form

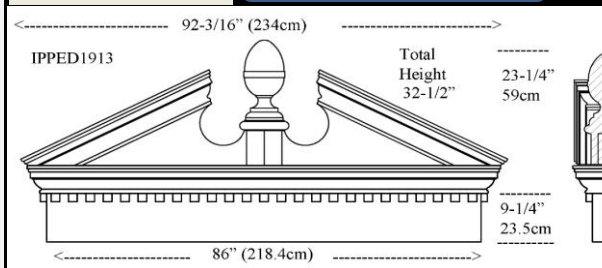

Materials	List	Each	10 +
ArchPolymer™	625.80	469.35	375.48

ITEM 22

IPPED1911

Brochure/Order Form

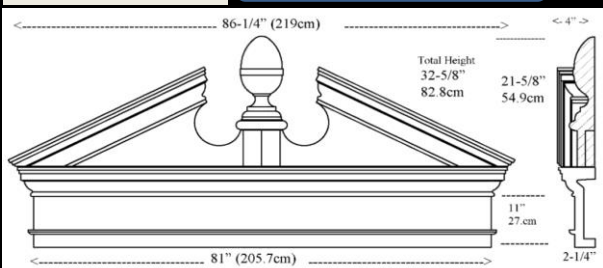

Materials	List	Each	10 +
ArchPolymer™	665.24	498.93	399.14

ITEM 19

IPPED1914

Brochure/Order Form

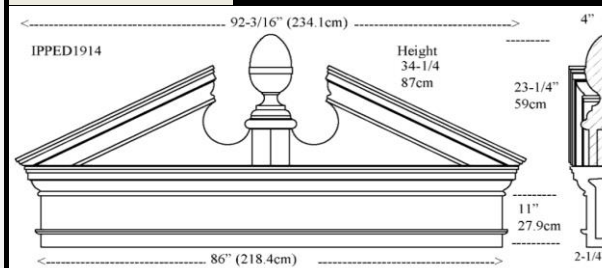

Materials	List	Each	10 +
ArchPolymer™	684.94	513.68	410.95

ITEM 23

IPPED907

Brochure/Order Form

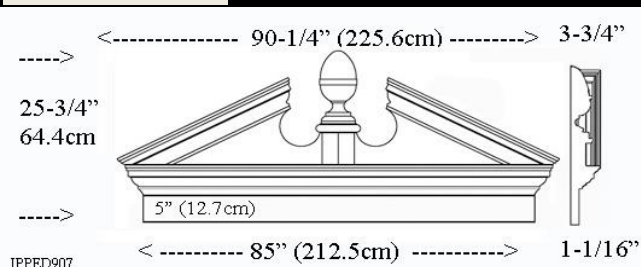

Materials	List	Each	10 +
ArchPolymer™	484.53	363.39	290.72

ITEM 20

IPPED908

Brochure/Order Form

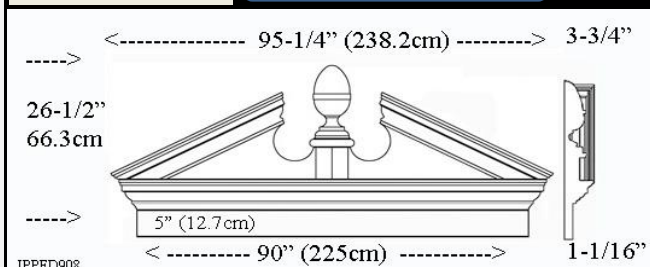

Materials	List	Each	10 +
ArchPolymer™	654.39	490.79	392.63

ITEM 24

Custom Sizes, Metal Coating, Painted Available



IPPED1915

Brochure/Order Form

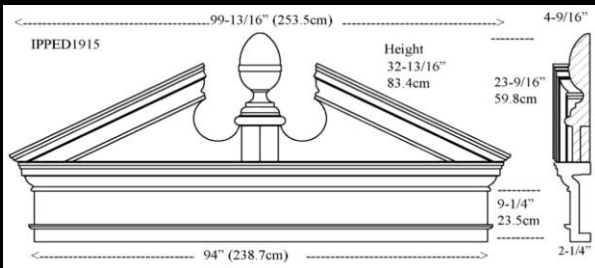

Materials	List	Each	10 +	ITEM 25
ArchPolymer™	700.32	525.24	420.19	

IPPED920

Brochure/Order Form

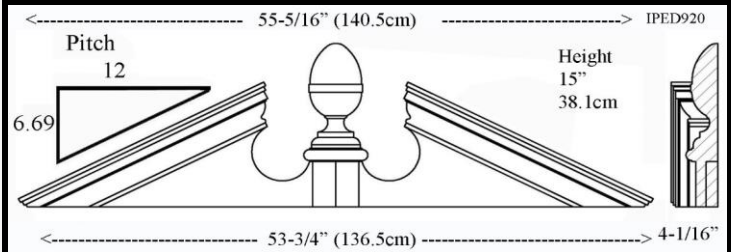

Materials	List	Each	10 +	ITEM 29
ArchPolymer™	168.63	126.47	101.18	

IPPED1916

Brochure/Order Form

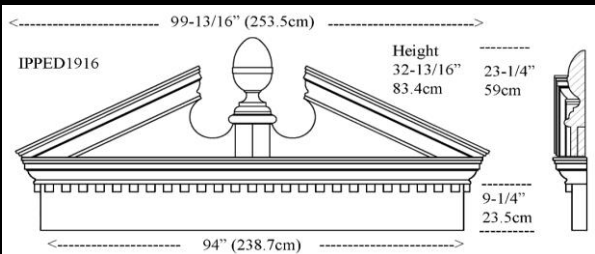

Materials	List	Each	10 +	ITEM 26
ArchPolymer™	712.86	534.64	427.71	

IPPED931

Brochure/Order Form

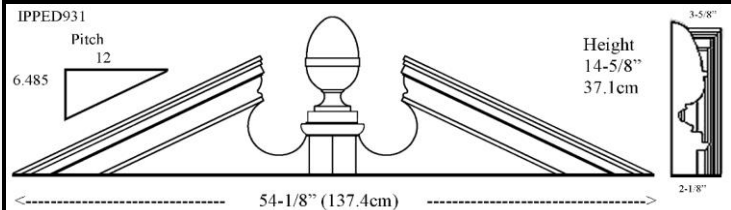

Materials	List	Each	10 +	ITEM 30
ArchPolymer™	198.43	148.82	119.06	

IPPED1917

Brochure/Order Form

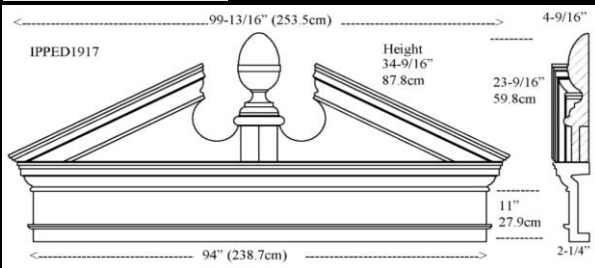

Materials	List	Each	10 +	ITEM 27
ArchPolymer™	774.25	580.69	464.55	

IPPED921

Brochure/Order Form

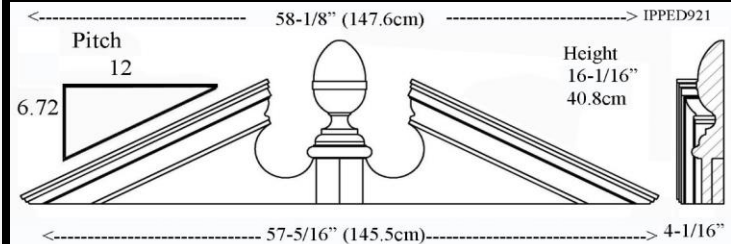

Materials	List	Each	10 +	ITEM 31
ArchPolymer™	196.34	147.23	117.79	

IPPED930

Brochure/Order Form

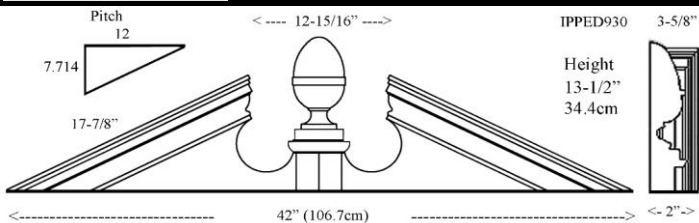

Materials	List	Each	10 +	ITEM 28
ArchPolymer™	197.84	148.38	118.71	

IPPED933

Brochure/Order Form

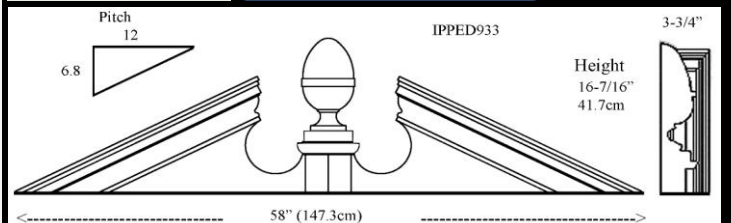

Materials	List	Each	10 +	ITEM 32
ArchPolymer™	217.34	162.98	130.38	



IPPED934

Brochure/Order Form

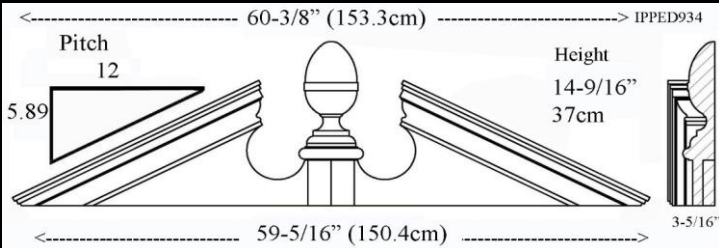

Materials	List	Each	10 +	ITEM 33
ArchPolymer™	227.15	170.36	136.29	

IPPED937

Brochure/Order Form

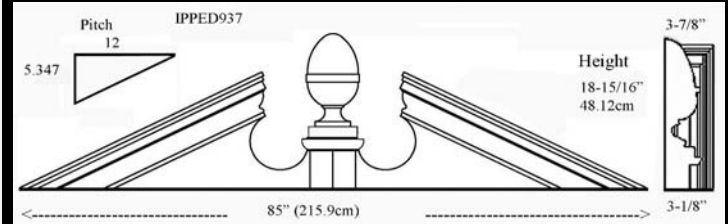

Materials	List	Each	10 +	ITEM 37
ArchPolymer™	337.34	252.98	202.39	

IPPED935

Brochure/Order Form

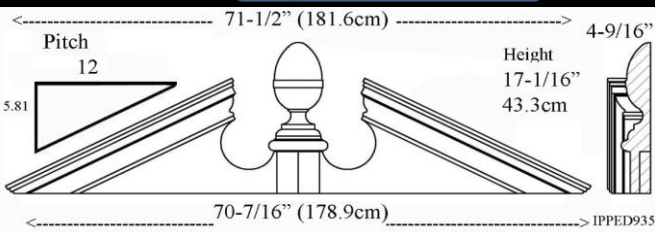

Materials	List	Each	10 +	ITEM 34
ArchPolymer™	291.02	218.26	174.61	

IPPED938

Brochure/Order Form

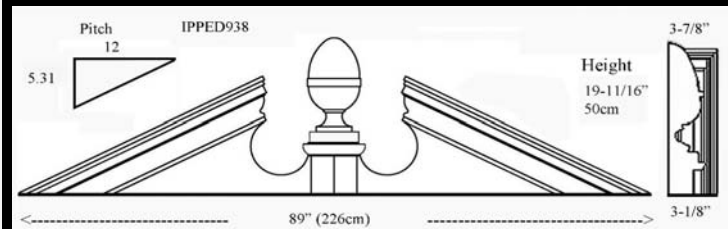

Materials	List	Each	10 +	ITEM 38
ArchPolymer™	363.56	272.67	218.13	

IPPED922

Brochure/Order Form

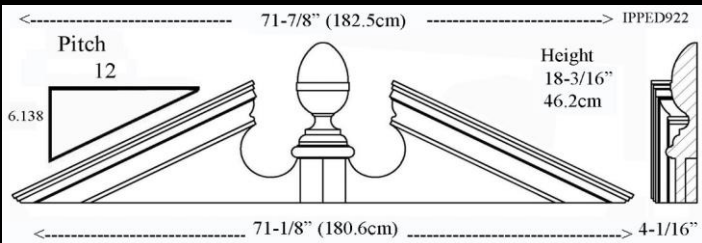

Materials	List	Each	10 +	ITEM 35
ArchPolymer™	325.87	244.40	195.52	

IPPED924

Brochure/Order Form

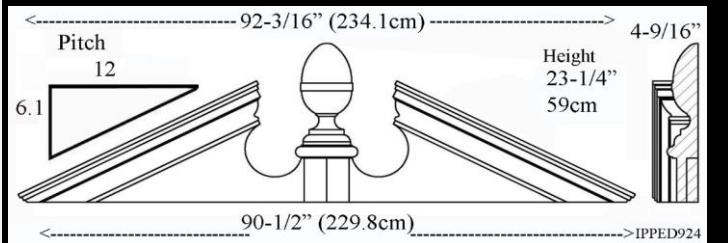

Materials	List	Each	10 +	ITEM 39
ArchPolymer™	368.62	276.46	221.17	

IPPED936

Brochure/Order Form

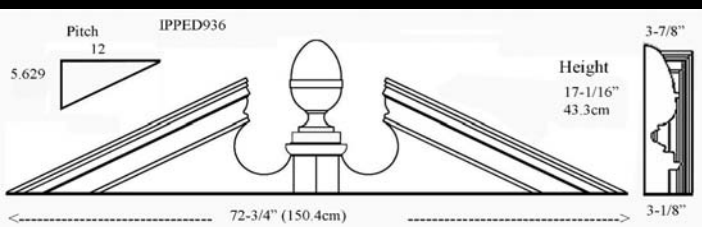

Materials	List	Each	10 +	ITEM 36
ArchPolymer™	304.17	228.12	182.50	

IPPED939

Brochure/Order Form

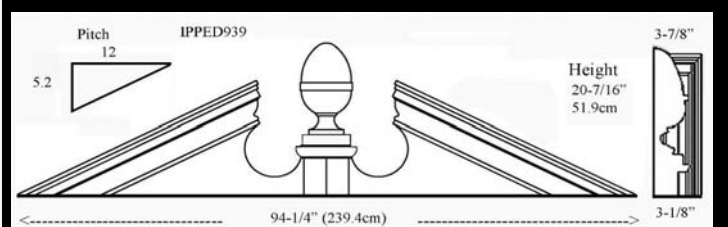

Materials	List	Each	10 +	ITEM 40
ArchPolymer™	393.04	294.78	235.82	

Custom Sizes, Metal Coating, Painted Available



IPPED923

Brochure/Order Form

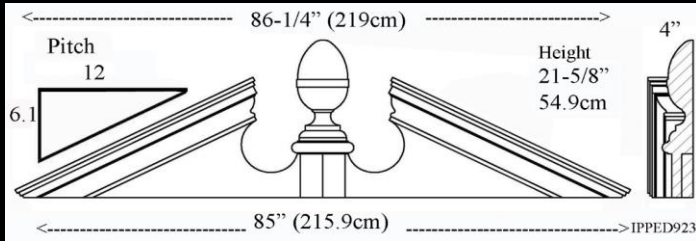

Materials	List	Each	50 +	ITEM 41
ArchPolymer™	357.45	268.08	214.47	

IPPED925

Brochure/Order Form

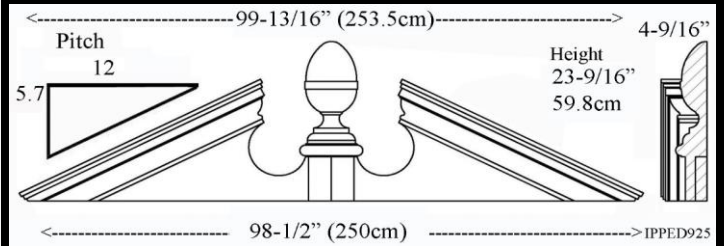

Materials	List	Each	50 +	ITEM 42
ArchPolymer™	513.86	385.39	308.31	

Design Ideas

The Pilasters are mounted on back boards which are lining up with the Facia Board.

The total width of the pediment exceeds the width of the pilasters, brickmold and door

Use the Facia Board to script the street address for a special touch!

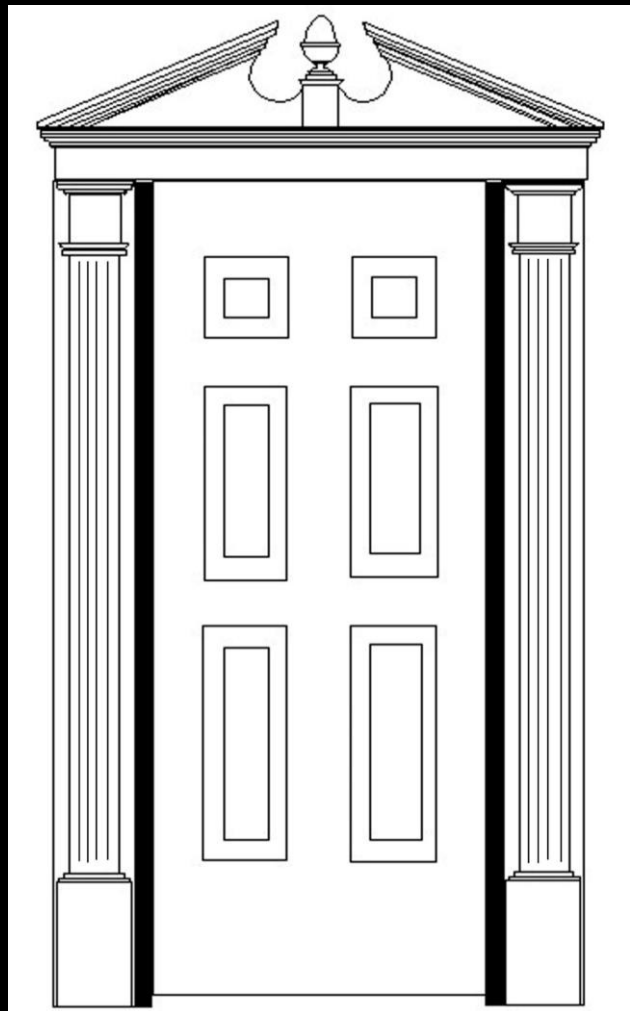

Custom Sizes, Metal Coating, Painted Available



Imperial Productions®



Acorn Pediments

with or without Frieze Boards

Contact Us

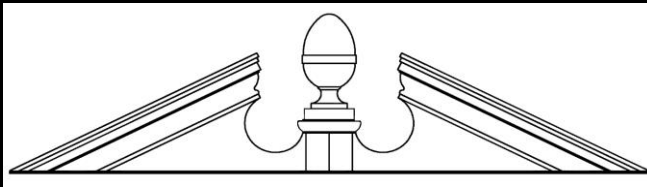
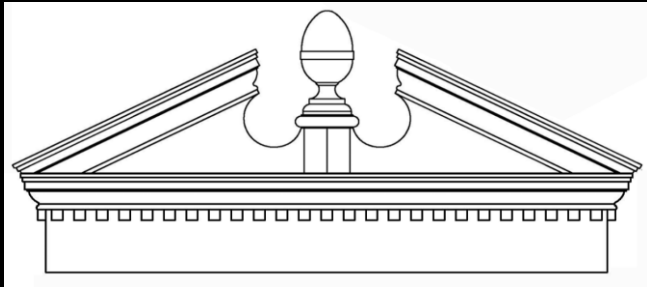
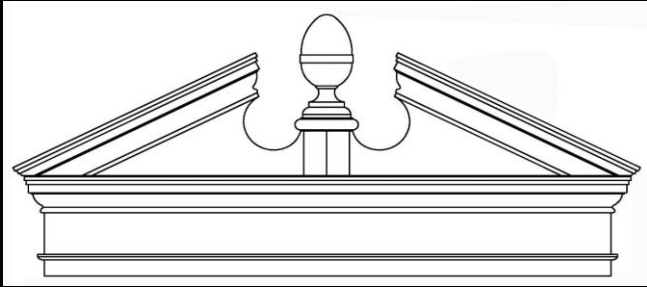

Decorate the Frieze Board with
a Panel Mold or Dentil Strip

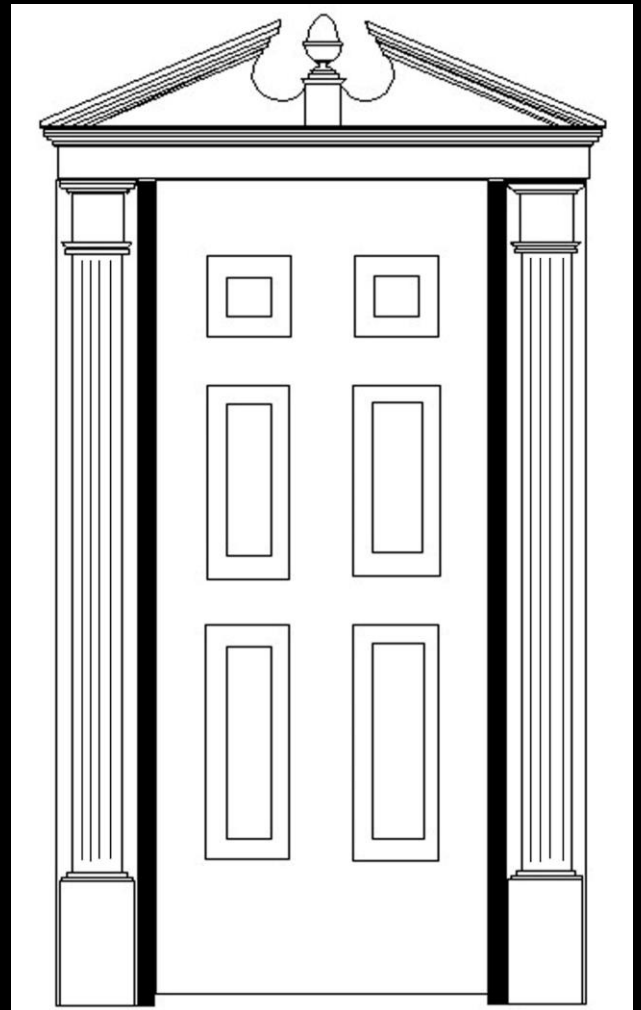

click to Watch Youtube Movie



Design Ideas

How to decorate a Frieze Board

a) Place the Street Name & #

b) click to select a decorative frieze

c) click to select an applique

2 Fluted Pilasters

It is architecturally correct to allow the pilasters to exceed the the horizontal Frieze Board in this drawing the pilasters are mounted on flat backboards

[click for Pilasters on our website](#)

Pilaster Plinths

Acorn

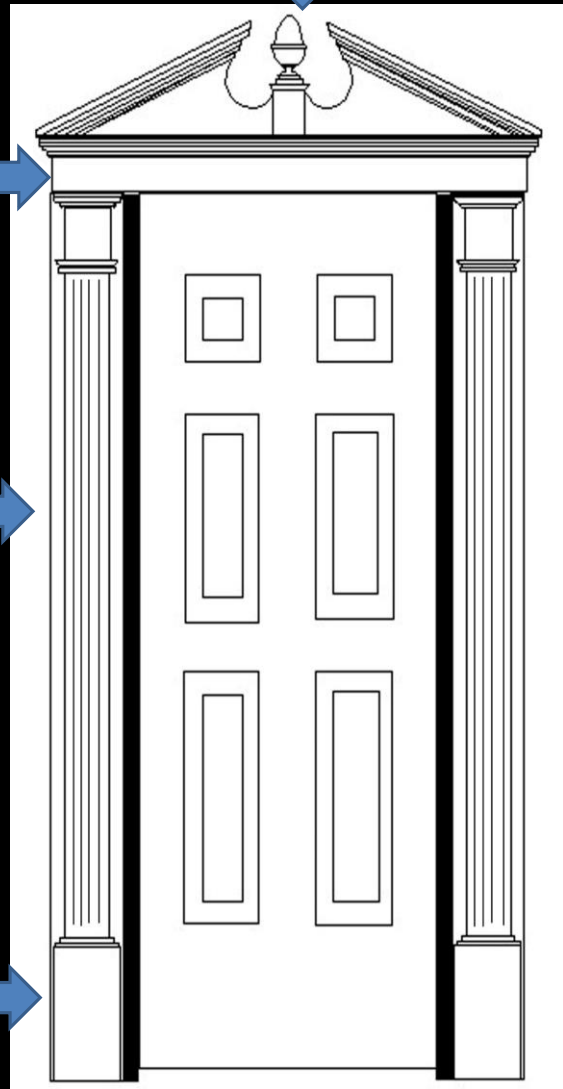

Brickmold

Separates Brick from the Door Casing

[click to no rot Brickmolds](#)

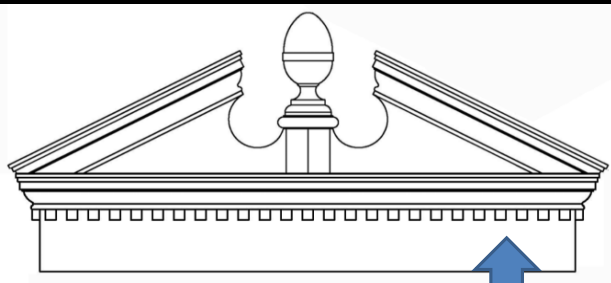

For Federal Style
Add Dentil Trim Strip

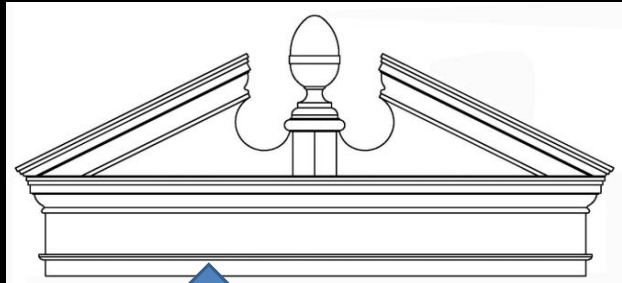

For Colonial Style
Add a Panel Mold



IPPED1900

Brochure/Order Form

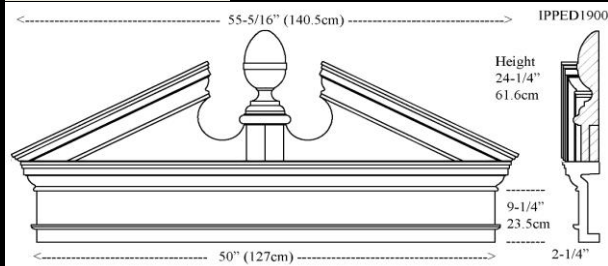

Materials	List	Each	10 +
ArchPolymer™	319.49	239.62	191.69

IPPED901

Brochure/Order Form

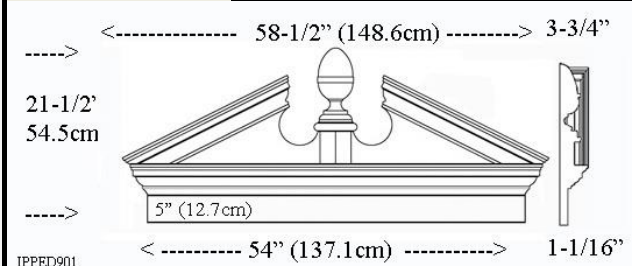

Materials	List	Each	10 +
ArchPolymer™	319.02	239.26	191.41

IPPED1901

Brochure/Order Form

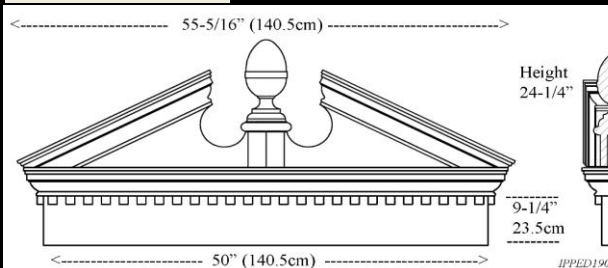

Materials	List	Each	10 +
ArchPolymer™	321.69	241.27	193.02

IPPED902

Brochure/Order Form

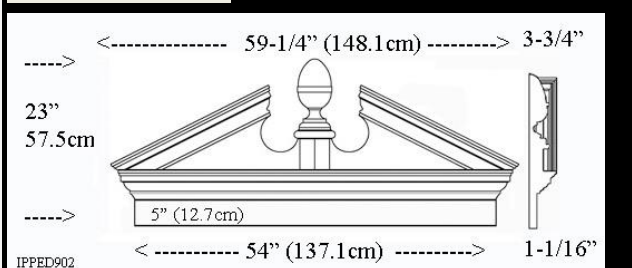

Materials	List	Each	10 +
ArchPolymer™	314.78	236.08	188.87

IPPED1904

Brochure/Order Form

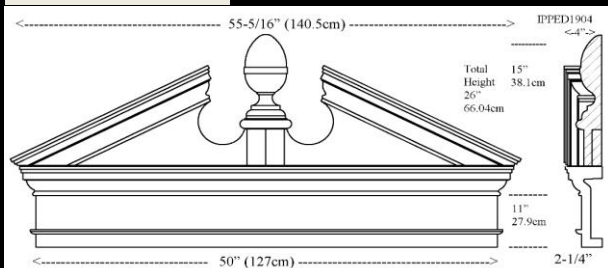

Materials	List	Each	10 +
ArchPolymer™	364.83	273.62	218.90

IPPED1902

Brochure/Order Form

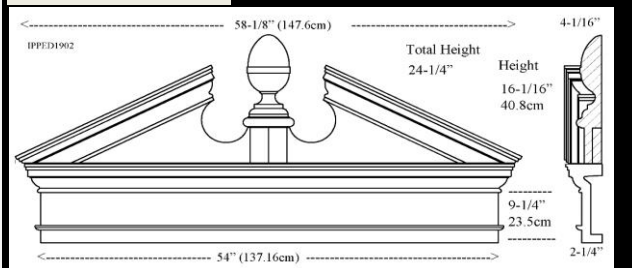

Materials	List	Each	10 +
ArchPolymer™	358.09	268.57	214.85

IPPED900

Brochure/Order Form

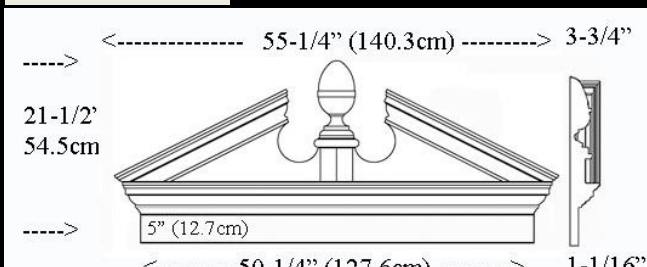

Materials	List	Each	10 +
ArchPolymer™	302.84	227.10	181.68

IPPED1903

Brochure/Order Form

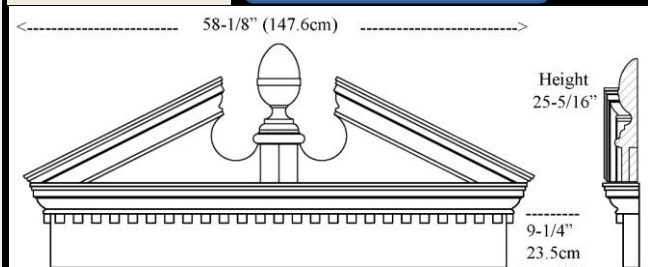

Materials	List	Each	10 +
ArchPolymer™	358.34	268.73	214.99



IPPED1905

Brochure/Order Form

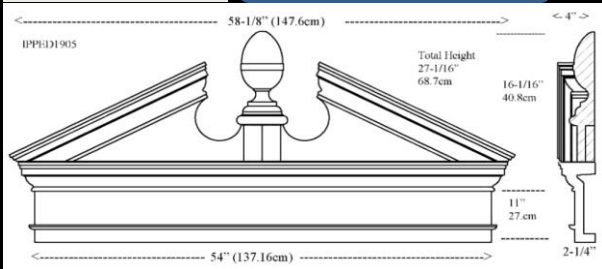

Materials	List	Each	10 +
ArchPolymer™	392.54	294.38	235.51

IPPED1908

Brochure/Order Form

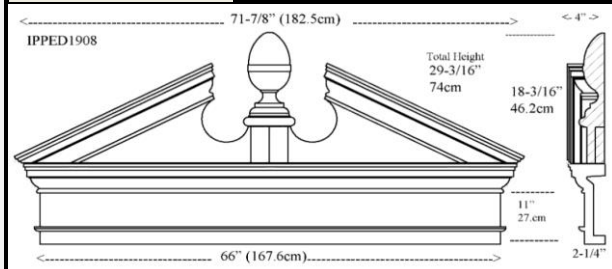

Materials	List	Each	10 +
ArchPolymer™	523.90	392.93	314.34

IPPED903

Brochure/Order Form

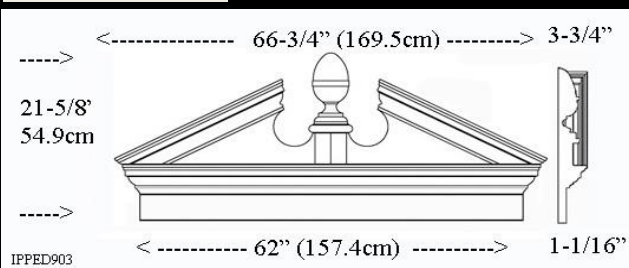

Materials	List	Each	10 +
ArchPolymer™	403.54	302.65	242.12

IPPED904

Brochure/Order Form

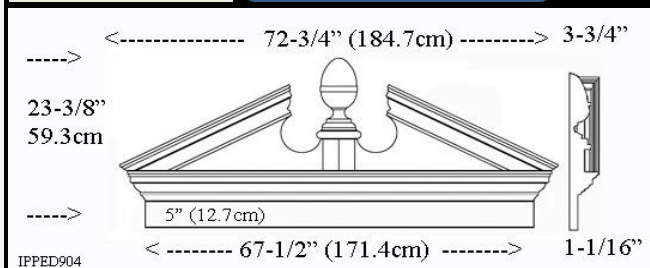

Materials	List	Each	10 +
ArchPolymer™	396.50	297.37	237.90

IPPED1906

Brochure/Order Form

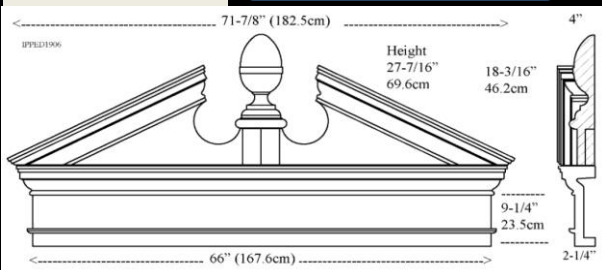

Materials	List	Each	10 +
ArchPolymer™	523.90	392.93	314.34

IPPED905

Brochure/Order Form

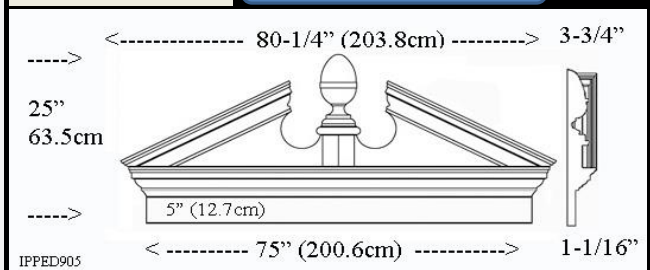

Materials	List	Each	10 +
ArchPolymer™	456.26	342.19	273.75

IPPED1907

Brochure/Order Form

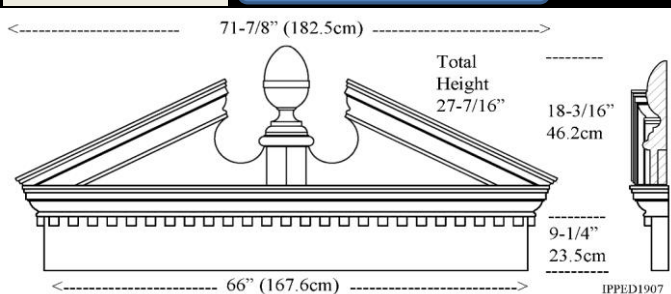

Materials	List	Each	10 +
ArchPolymer™	523.90	392.93	314.34

IPPED906

Brochure/Order Form

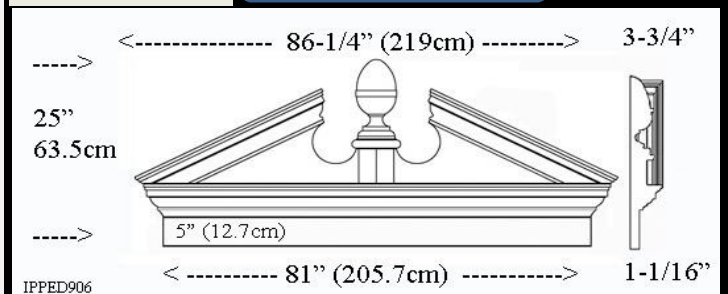

Materials	List	Each	10 +
ArchPolymer™	484.53	363.39	290.72



IPPED1909

Brochure/Order Form

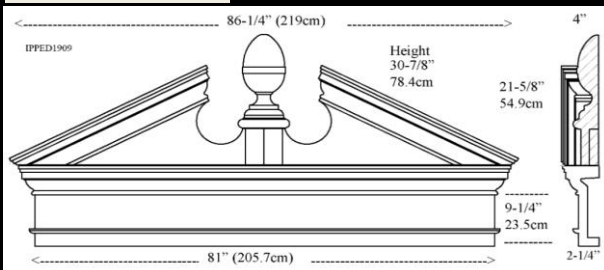

Materials	List	Each	10 +
ArchPolymer™	608.54	456.40	365.12

IPPED1912

Brochure/Order Form

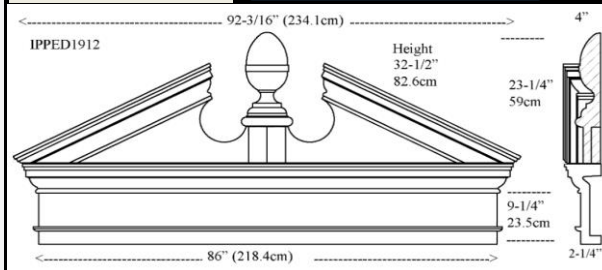

Materials	List	Each	10 +
ArchPolymer™	626.59	469.94	375.95

IPPED1910

Brochure/Order Form

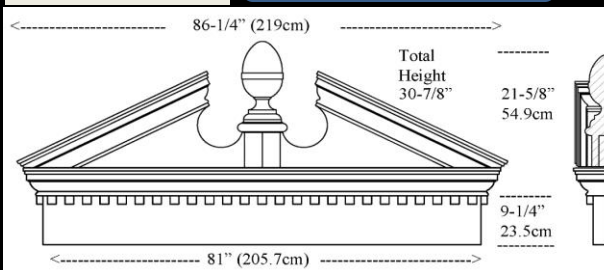

Materials	List	Each	10 +
ArchPolymer™	608.54	456.40	365.12

IPPED1913

Brochure/Order Form

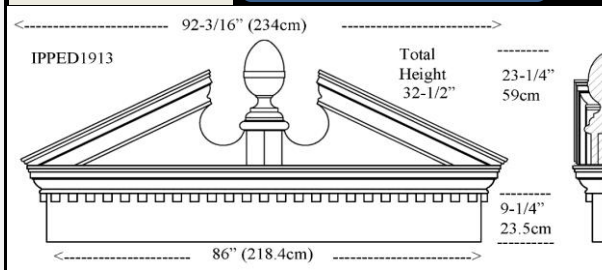

Materials	List	Each	10 +
ArchPolymer™	625.80	469.35	375.48

IPPED1911

Brochure/Order Form

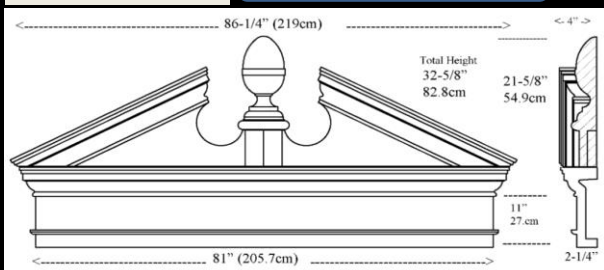

Materials	List	Each	10 +
ArchPolymer™	665.24	498.93	399.14

IPPED1914

Brochure/Order Form

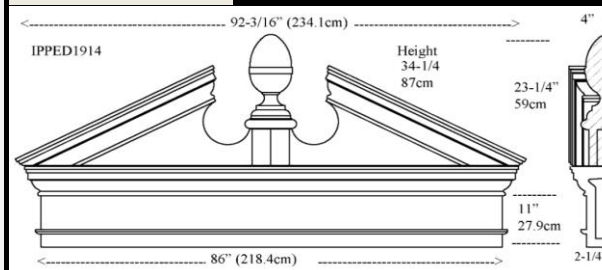

Materials	List	Each	10 +
ArchPolymer™	684.94	513.68	410.95

IPPED907

Brochure/Order Form

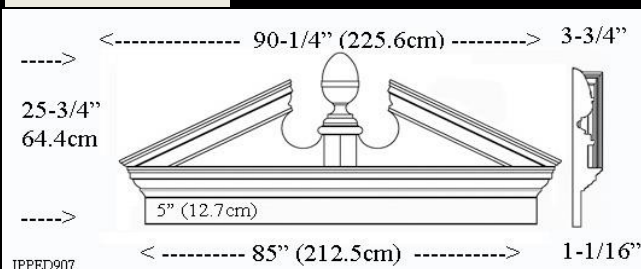

Materials	List	Each	10 +
ArchPolymer™	484.53	363.39	290.72

IPPED908

Brochure/Order Form

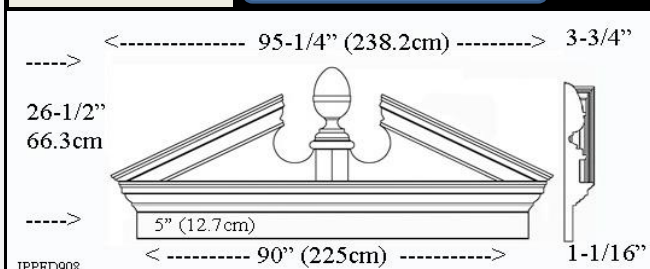

Materials	List	Each	10 +
ArchPolymer™	654.39	490.79	392.63

Custom Sizes, Metal Coating, Painted Available



IPPED1915

Brochure/Order Form

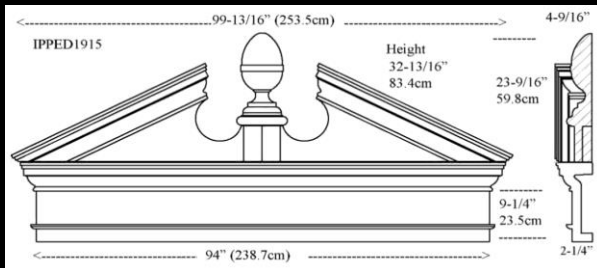

Materials	List	Each	10 +
ArchPolymer™	700.32	525.24	420.19

IPPED1916

Brochure/Order Form

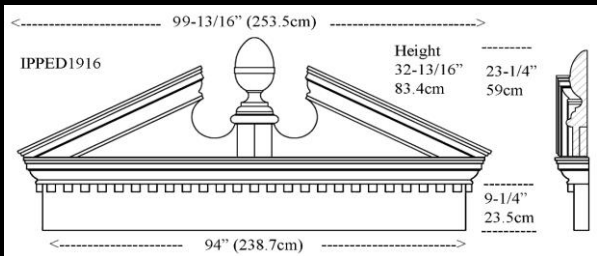

Materials	List	Each	10 +
ArchPolymer™	712.86	534.64	427.71

IPPED1917

Brochure/Order Form

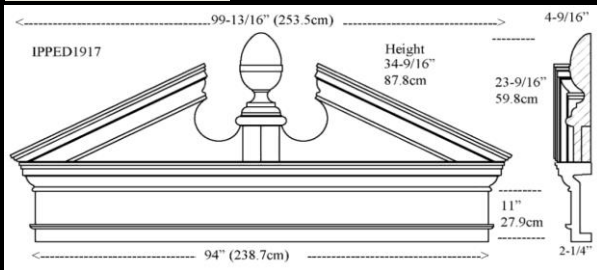

Materials	List	Each	10 +
ArchPolymer™	774.25	580.69	464.55

IPPED930

Brochure/Order Form

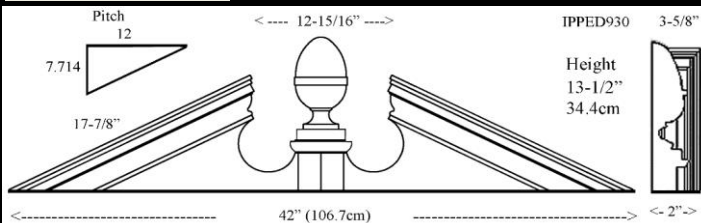

Materials	List	Each	10 +
ArchPolymer™	197.84	148.38	118.71

IPPED920

Brochure/Order Form

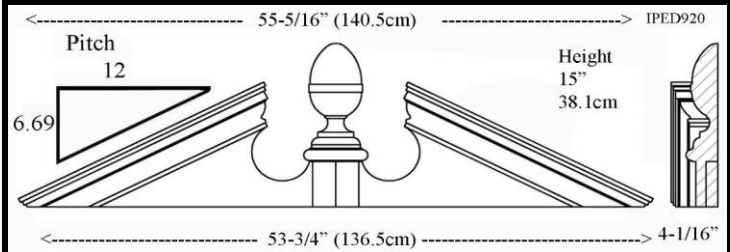

Materials	List	Each	10 +
ArchPolymer™	168.63	126.47	101.18

IPPED931

Brochure/Order Form

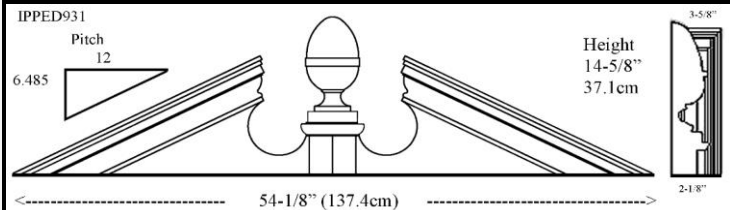

Materials	List	Each	10 +
ArchPolymer™	198.43	148.82	119.06

IPPED921

Brochure/Order Form

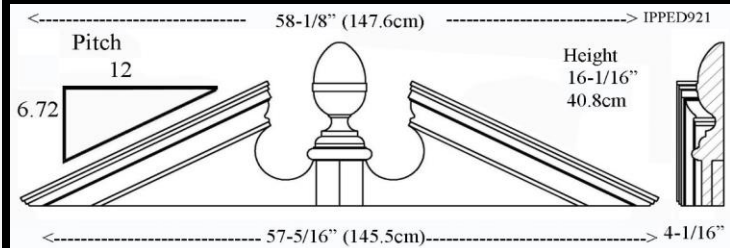

Materials	List	Each	10 +
ArchPolymer™	196.34	147.23	117.79

IPPED933

Brochure/Order Form

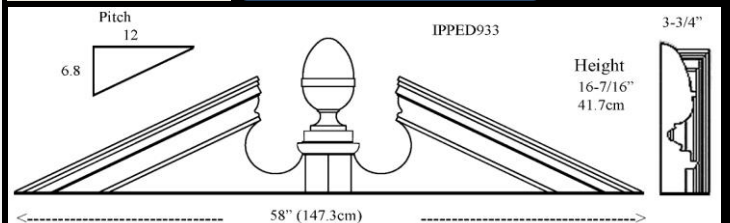

Materials	List	Each	10 +
ArchPolymer™	217.34	162.98	130.38



IPPED934

Brochure/Order Form

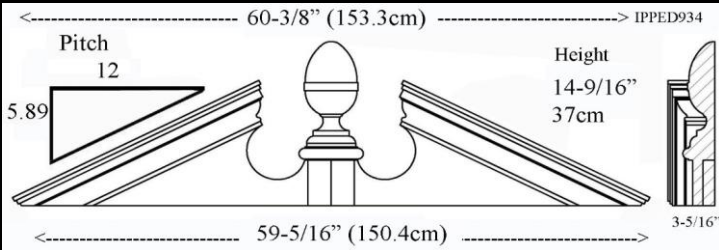

Materials	List	Each	10 +
ArchPolymer™	227.15	170.36	136.29

IPPED937

Brochure/Order Form

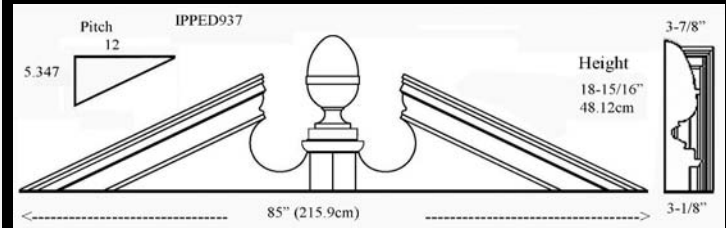

Materials	List	Each	10 +
ArchPolymer™	337.34	252.98	202.39

IPPED935

Brochure/Order Form

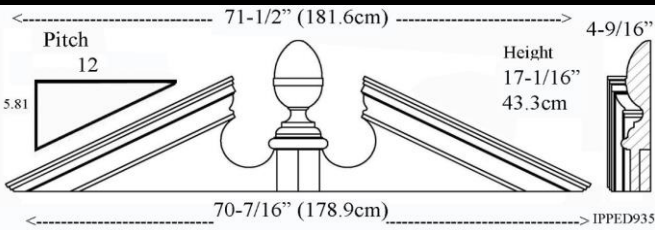

Materials	List	Each	10 +
ArchPolymer™	291.02	218.26	174.61

IPPED938

Brochure/Order Form

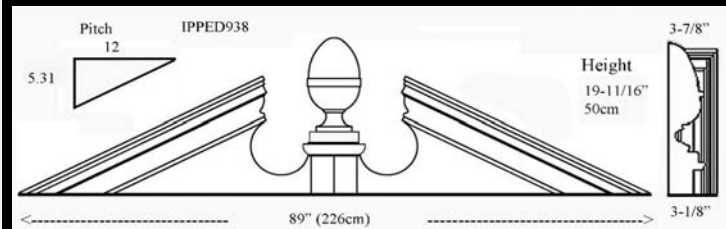

Materials	List	Each	10 +
ArchPolymer™	363.56	272.67	218.13

IPPED922

Brochure/Order Form

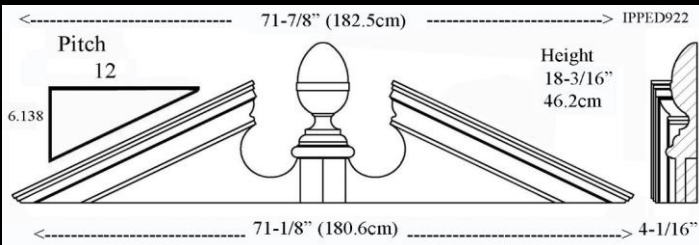

Materials	List	Each	10 +
ArchPolymer™	325.87	244.40	195.52

IPPED924

Brochure/Order Form

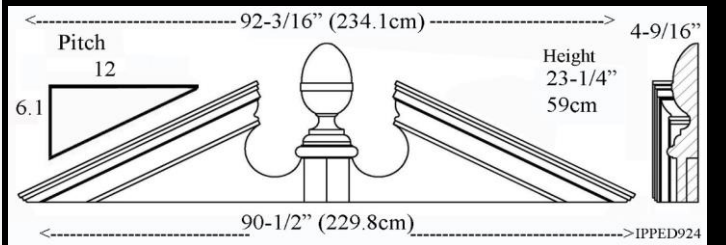

Materials	List	Each	10 +
ArchPolymer™	368.62	276.46	221.17

IPPED936

Brochure/Order Form

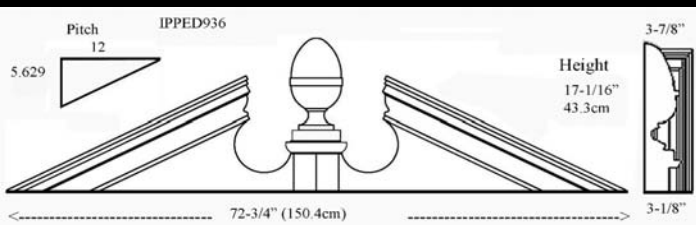

Materials	List	Each	10 +
ArchPolymer™	304.17	228.12	182.50

IPPED939

Brochure/Order Form

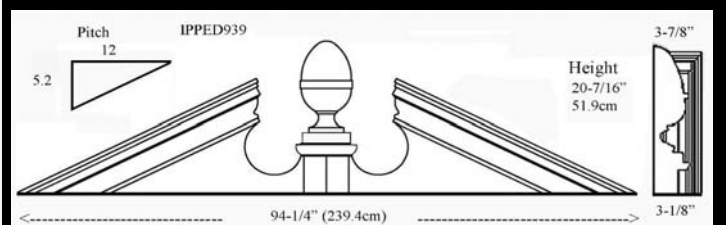

Materials	List	Each	10 +
ArchPolymer™	393.04	294.78	235.82

Custom Sizes, Metal Coating, Painted Available



IPPED923

Brochure/Order Form

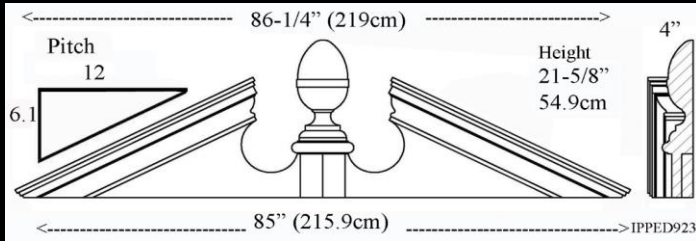

Materials	List	Each	50 +
ArchPolymer™	357.45	268.08	214.47

IPPED925

Brochure/Order Form

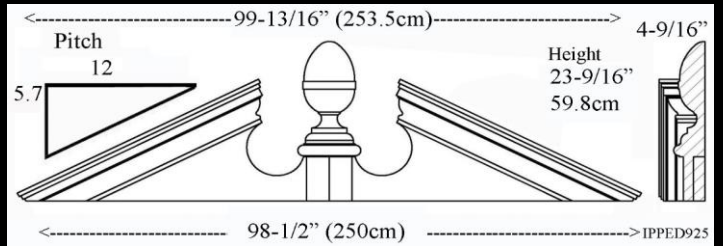

Materials	List	Each	50 +
ArchPolymer™	513.86	385.39	308.31

Design Ideas

The Pilasters are mounted on back boards which are lining up with the Facia Board.

The total width of the pediment exceeds the width of the pilasters, brickmold and door

Use the Facia Board to script the street address for a special touch!

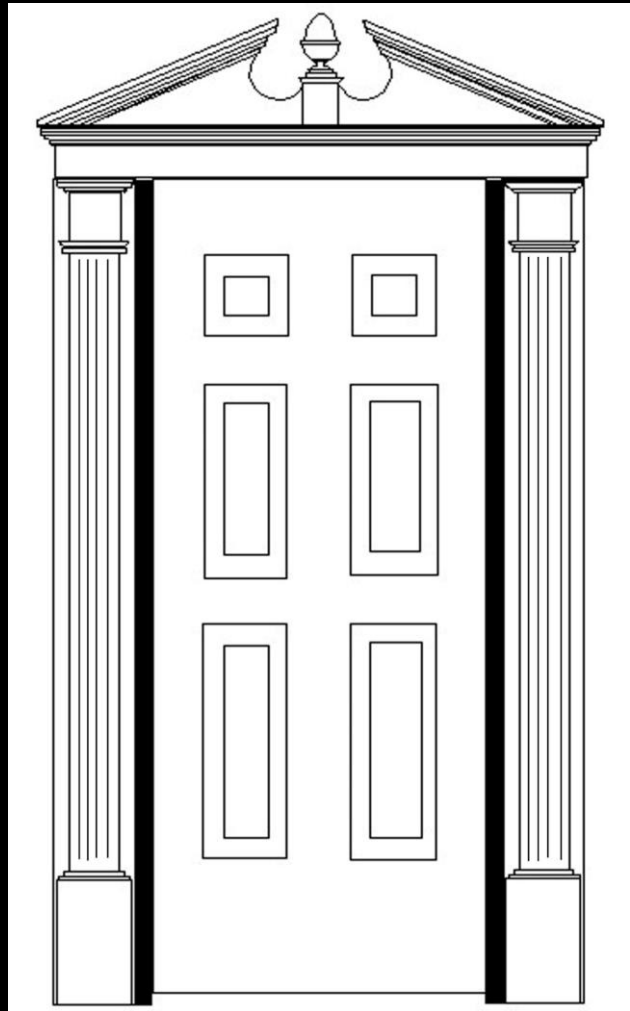

Custom Sizes, Metal Coating, Painted Available



Acorn Pediment Design # 2

Build Your Own

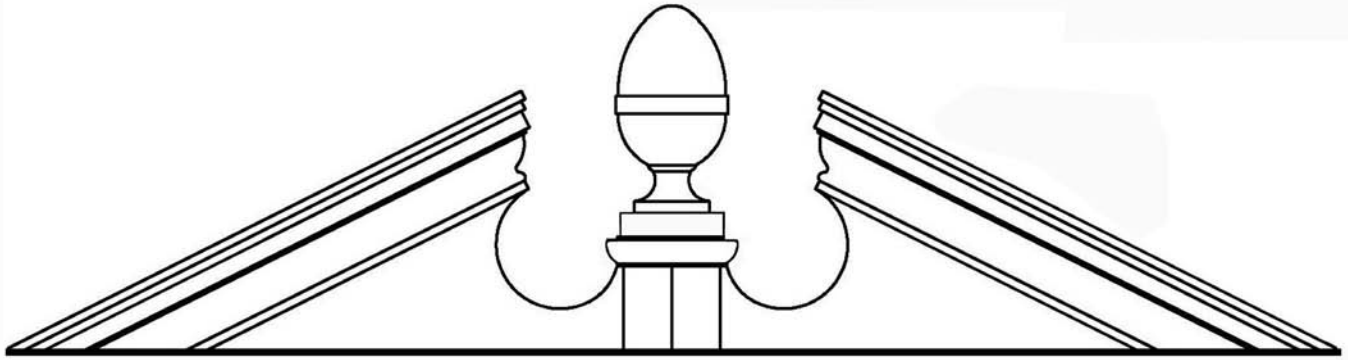

< -----

A) Bottom Width

----->

| - C) Depth

A = Bottom Width _____

H =
Total Height

H = Height _____

C = Depth _____

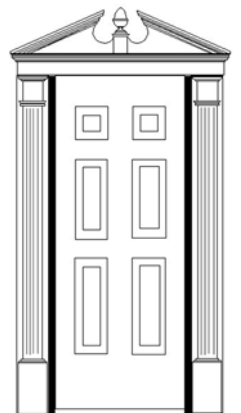

Select Material: ArchPolymer or GRG-NeoPlaster



Imperial Productions®

1-800-399-7585

Imperial Productions & Distribution Inc New York / Toronto

email sales@imperialproductions.com copyright 2016 MRDCI All Rights Reserved



Acorn Pediment Design # 3

Build Your Own

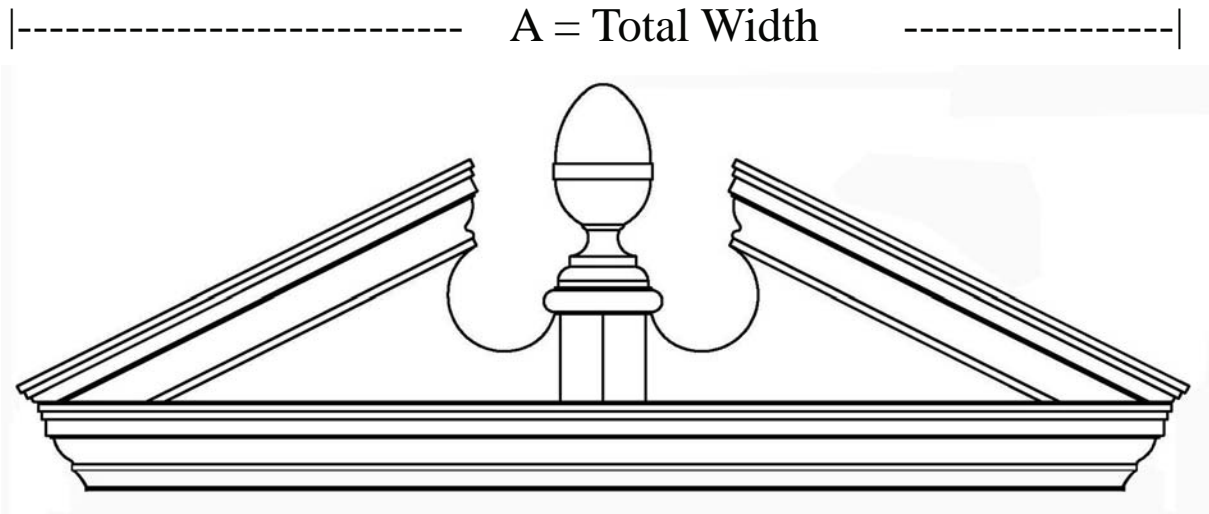

D = Moulding Bottom

|- C) Depth

H =
Total Height



E = Facia Depth

A = Total Width _____

B = Cornice Height _____

C = Depth _____

D = Bottom Moulding

Width _____

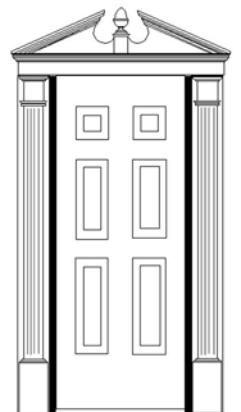

Select Material: ArchPolymer or GRG-NeoPlaster



Imperial Productions®

1-800-399-7585

Imperial Productions & Distribution Inc New York / Toronto

email sales@imperialproductions.com copyright 2016 MRDCI All Rights Reserved



Acorn Pediment Design # 1A

Build Your Own with Frieze Board

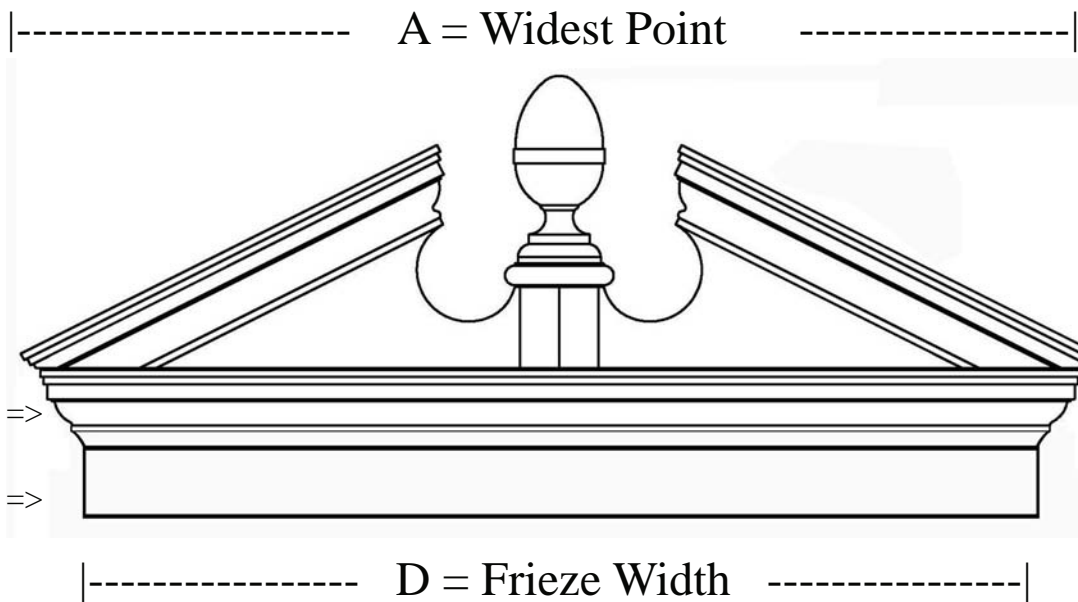
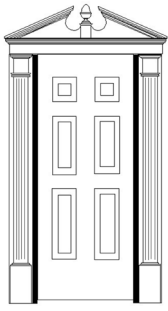

C) TopDepth

Half Acorn

Full Acorn

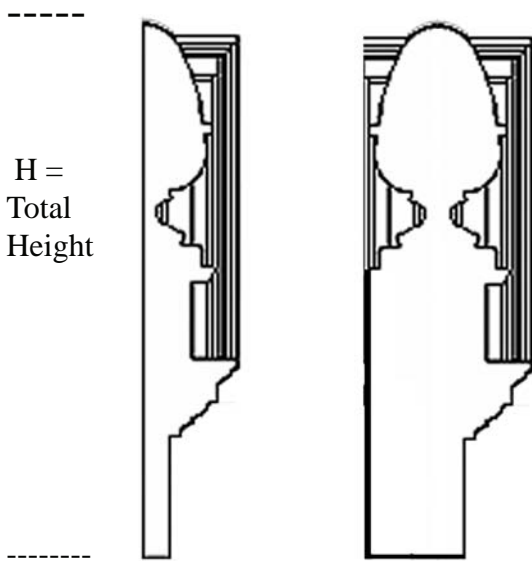

A = Widest Point _____

H1 = Cornice Height _____

H2 = Frieze Height _____

H = Total Height _____

C = Top Depth _____

E = Frieze Depth _____

Full Acorn or 1/2 Acorn (*circle*)

Select Material: ArchPolymer or GRG-NeoPlaster



Imperial Productions®

1-800-399-7585

Imperial Productions & Distribution Inc New York / Toronto

email sales@imperialproductions.com copyright 2016 MRDCI All Rights Reserved



Acorn Pediment Design # 1B

Build Your Own with Frieze and Trim

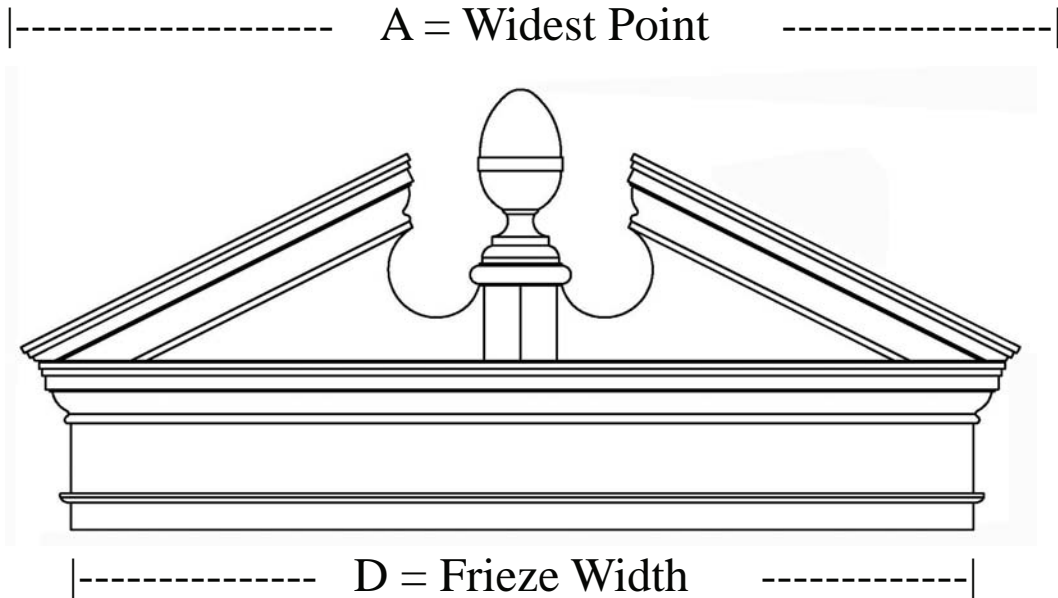
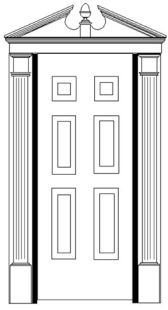

H1= Cornice =>

H2= Frieze =>
Board

C) TopDepth

Half Acorn

Full Acorn

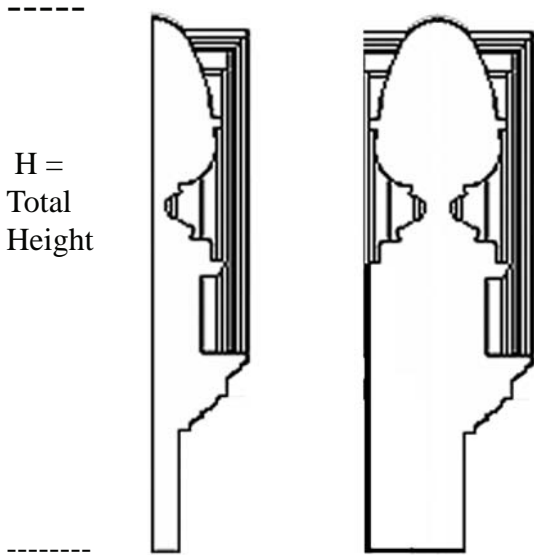

A = Widest Point _____

H1 = Cornice Height _____

H2 = Frieze Height _____

H = Total Height _____

C = Top Depth _____

E = Frieze Depth _____

Full Acorn or 1/2 Acorn (*circle*)

Select Material: ArchPolymer or GRG-NeoPlaster



Imperial Productions®

1-800-399-7585

Imperial Productions & Distribution Inc New York / Toronto

email sales@imperialproductions.com copyright 2016 MRDCI All Rights Reserved



Acorn Pediment Design # 1C

Build Your Own with Frieze, Trim, Dentil

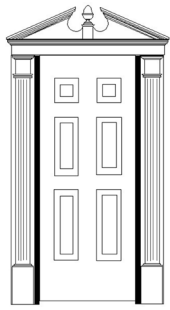

----- A = Widest Point -----

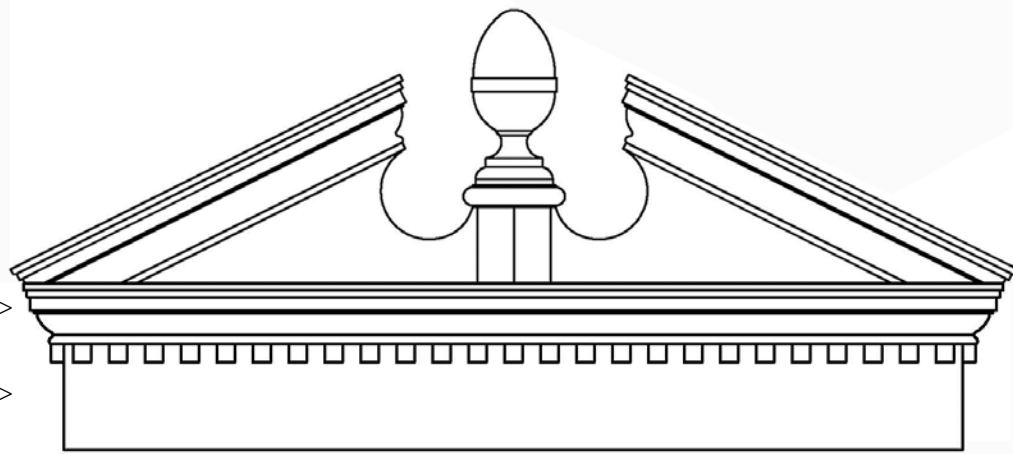

H1= Cornice =>

H2= Frieze =>
Board

----- D = Frieze Width -----

C) TopDepth

A = Widest Point _____

Half Acorn

Full Acorn

H1 = Cornice Height _____

H =
Total
Height



H2 = Frieze Height _____

H = Total Height _____

C = Top Depth _____

E = Frieze Depth _____

E= Frieze Depth

Full Acorn or 1/2 Acorn (*circle*)

Select Material: ArchPolymer or GRG-NeoPlaster



Imperial Productions®

1-800-399-7585

Imperial Productions & Distribution Inc New York / Toronto

email sales@imperialproductions.com copyright 2016 MRDCI All Rights Reserved



Imperial Productions® Request for Quote

Download, Fill-in & Email to sales@imperialproductions.com

Name / Company: _____

Phone _____ Email _____

Billing Address: _____

City: _____ Prov / State _____

PC / Zip Code _____

Ship to Address: _____

City: _____ Prov / State _____

PC / Zip Code _____

Product Code: _____

Quantity: _____

Notes: _____



Imperial Productions®

1-800-399-7585

Imperial Productions & Distribution Inc Toronto / New York

email sales@imperialproductions.com copyright 2016 MRDCI All Rights Reserved