



Imperial Productions®



# Doric Capitals

## Decorative



ImperialProductions®

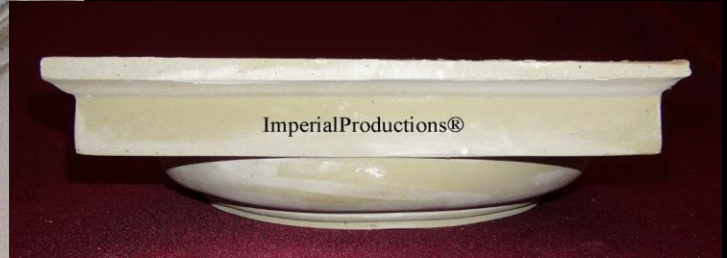

SPLIT OPTIONS



IPPCTC06	Hole 5-1/4"		
<b>EconPolymer™</b>	List	Each	6 +
Whole	<b>30.34</b>	<b>22.76</b>	<b>18.21</b>
Split in Half (Pilaster)	<b>36.06</b>	<b>27.05</b>	<b>21.64</b>
Whole White Painted	<b>46.73</b>	<b>35.05</b>	<b>28.04</b>
Split in Half White Painted	<b>52.45</b>	<b>39.34</b>	<b>31.47</b>

ITEM 1

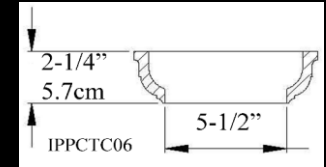
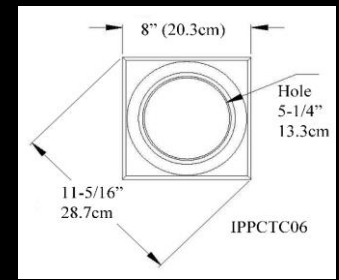

Cap (EconPolymer)

[click for Brochure/Order Form](#)

IPPCTC08	Hole 6-1/4"		
<b>EconPolymer™</b>	List	Each	6 +
Whole	<b>30.57</b>	<b>22.93</b>	<b>18.34</b>
Split in Half (Pilaster)	<b>46.39</b>	<b>34.79</b>	<b>27.83</b>
Whole White Painted	<b>54.08</b>	<b>40.56</b>	<b>32.45</b>
Split in Half White Painted	<b>69.93</b>	<b>52.45</b>	<b>41.96</b>

ITEM 2

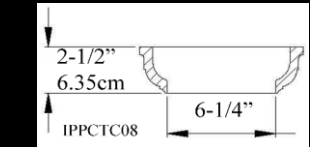
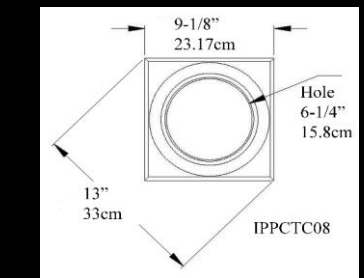

Cap (EconPolymer)

[click for Brochure/Order Form](#)

IPDC08	Hole 6-1/2"		
<b>FRP-PolyComp™</b>	List	Each	6 +
Whole	<b>74.47</b>	<b>72.83</b>	<b>74.47</b>
Split for Post Wrap	<b>95.64</b>	<b>93.54</b>	<b>95.64</b>
Split in Half (Pilaster)	<b>96.08</b>	<b>93.96</b>	<b>96.08</b>

ITEM 9

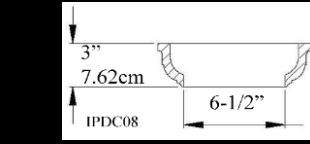
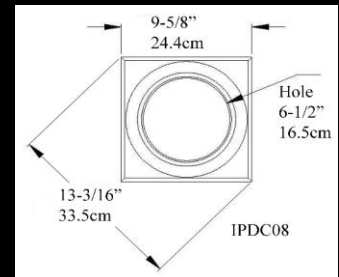

Cap (EconPolymer)

[click for Brochure/Order Form](#)



IPPCTC08NT	Hole 7-5/8"		
<b>EconPolymer™</b>	List	Each	6 +
Whole	<b>27.46</b>	<b>20.59</b>	<b>16.47</b>
Split in Half (Pilaster)	<b>34.75</b>	<b>26.06</b>	<b>20.85</b>
Whole White Painted	<b>50.99</b>	<b>38.25</b>	<b>30.60</b>
Split in Half White Painted	<b>58.29</b>	<b>43.72</b>	<b>34.97</b>

ITEM 2

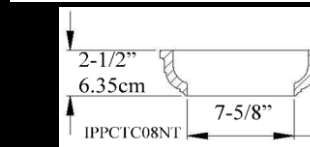
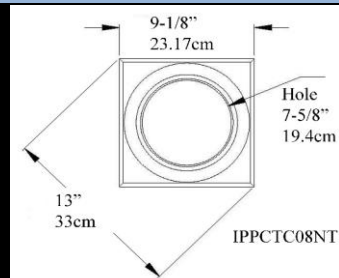

Cap (EconPolymer)

[click for Brochure/Order Form](#)



IPDC10	Hole 7-3/4"		
FRP-PolyComp™	List	Each	6 +
Whole	78.35	76.63	78.35
Split for Post Wrap	99.52	97.34	99.52
Split in Half (Pilaster)	99.98	97.78	99.98

ITEM 9

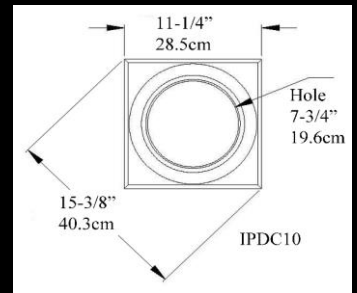

[click for Brochure/Order Form](#)

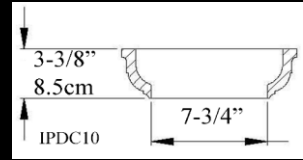

IPPCTC10	Hole 8-1/8"		
EconPolymer™	List	Each	6 +
Whole	43.73	32.80	26.24
Split in Half (Pilaster)	53.45	40.09	32.07
Whole White Painted	79.59	59.70	47.76
Split in Half White Painted	89.35	67.01	53.61

ITEM 2

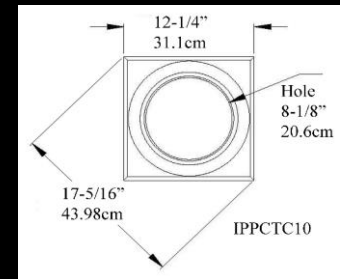

[click for Brochure/Order Form](#)

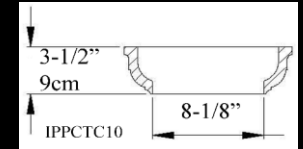

IPDC12	Hole 9-1/2"		
FRP-PolyComp™	List	Each	6 +
Whole	179.11	175.17	179.11
Split for Post Wrap	200.28	195.88	200.28
Split in Half (Pilaster)	201.19	196.77	201.19

ITEM 9

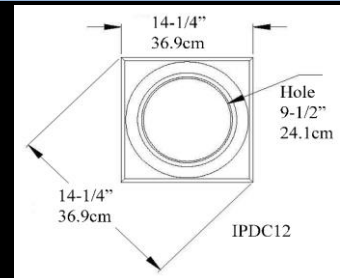

[click for Brochure/Order Form](#)

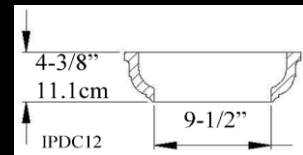

IPPCTC12	Hole 9-5/8"		
EconPolymer™	List	Each	6 +
Whole	58.63	43.97	35.18
Split in Half (Pilaster)	71.30	53.47	42.78
Whole White Painted	120.18	90.13	72.11
Split in Half White Painted	132.85	99.64	79.71

ITEM 2

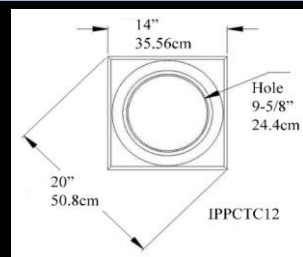

[click for Brochure/Order Form](#)

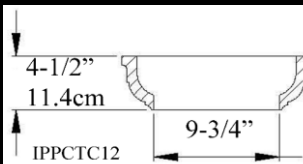



IPPCTC10NT	Hole 9-7/8"		
EconPolymer™	List	Each	6 +
Whole	43.73	32.80	26.24
Split in Half (Pilaster)	49.48	37.11	29.69
Whole White Painted	79.59	59.70	47.76
Split in Half White Painted	85.34	64.01	51.21

ITEM 2

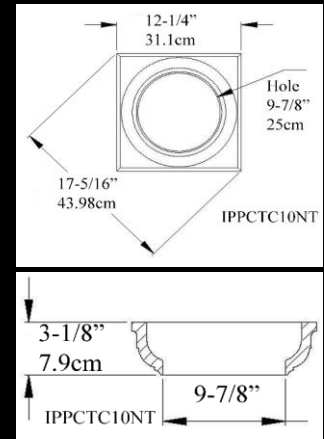

Cap (EconPolymer)

[click for Brochure/Order Form](#)

IPDC14	Hole 11-3/4"		
FRP-PolyComp™	List	Each	6 +
Whole	515.62	504.28	515.62
Split for Post Wrap	536.80	524.99	536.80
Split in Half (Pilaster)	539.24	527.37	539.24

ITEM 9

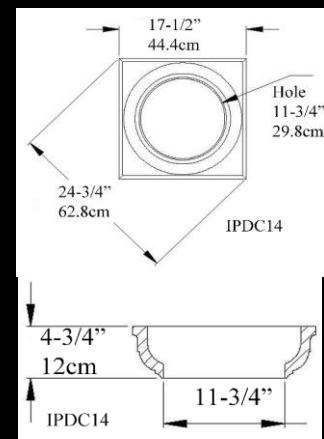

[click for Brochure/Order Form](#)



IPPCTC12NT	Hole 11-3/4"		
EconPolymer™	List	Each	6 +
Whole	58.69	44.02	35.21
Split in Half (Pilaster)	71.30	53.47	42.78
Whole White Painted	120.24	90.15	72.12
Split in Half White Painted	132.85	99.64	79.71

ITEM 2

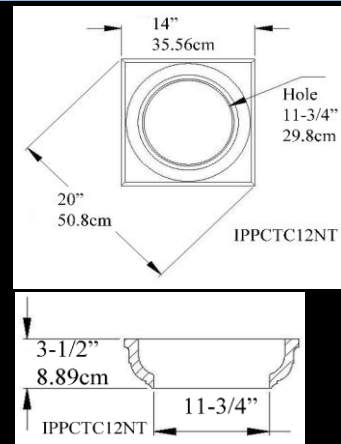

Cap (EconPolymer)

[click for Brochure/Order Form](#)

IPPCTC14	Hole 12-1/8"		
EconPolymer™	List	Each	6 +
Whole	130.96	98.22	78.58
Split in Half (Pilaster)	147.46	110.60	88.48
Whole White Painted	199.14	149.33	119.47
Split in Half White Painted	215.62	161.71	129.37

ITEM 2

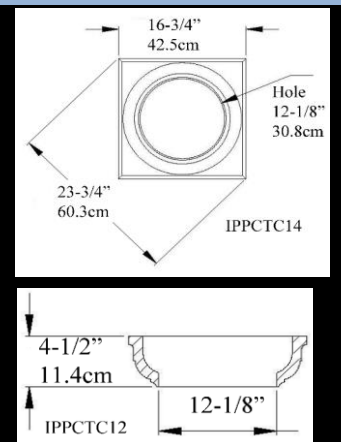

Cap (EconPolymer)

[click for Brochure/Order Form](#)



IPPCTC16	Hole 14"		
EconPolymer™	List	Each	6 +
Whole	166.37	124.77	99.82
Split in Half (Pilaster)	187.79	140.84	112.67
Whole White Painted	245.02	183.76	147.01
Split in Half White Painted	266.44	199.83	159.86

ITEM 2

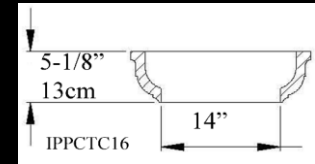
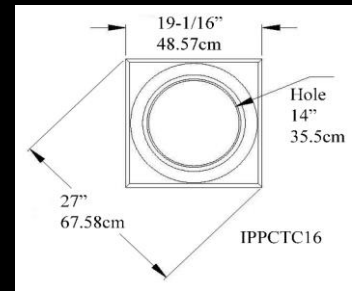

Cap (EconPolymer)

[click for Brochure/Order Form](#)

IPPCTC14NT	Hole 14-1/8"		
EconPolymer™	List	Each	6 +
Whole	130.99	98.24	78.59
Split in Half (Pilaster)	147.46	110.60	88.48
Whole White Painted	199.14	149.36	119.49
Split in Half White Painted	215.62	161.71	129.37

ITEM 2

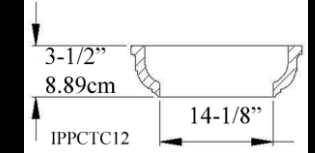
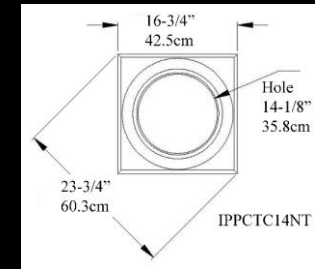

Cap (EconPolymer)

[click for Brochure/Order Form](#)

IPDC16	Hole 14-1/4"		
FRP-PolyComp™	List	Each	6 +
Whole	543.33	531.37	543.33
Split for Post Wrap	611.44	597.99	611.44
Split in Half (Pilaster)	614.22	600.71	614.22

ITEM 9

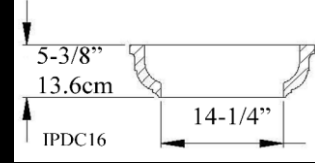
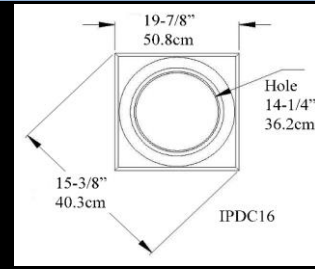

Cap (FRP-PolyComp)

[click for Brochure/Order Form](#)



IPPCTC18	Hole 15-3/4"		
EconPolymer™	List	Each	6 +
Whole	308.42	231.32	185.05
Split in Half (Pilaster)	336.25	252.19	201.75
Whole White Painted	405.18	303.88	243.11
Split in Half White Painted	433.03	324.77	259.82

ITEM 2

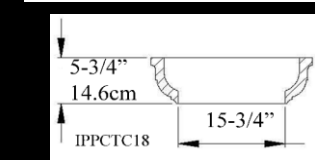
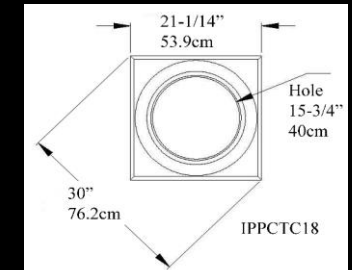

Cap (EconPolymer)

[click for Brochure/Order Form](#)



IPDC18	Hole 16"			
	FRP-PolyComp™	List	Each	6 +
Whole	767.08	750.20	767.08	
Split for Post Wrap	835.19	816.82	835.19	
Split in Half (Pilaster)	838.99	820.53	838.99	

ITEM 9

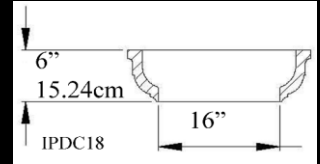
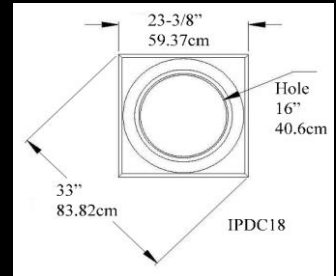

[click for Brochure/Order Form](#)



IPPCTC20	Hole 16-3/4"			
	EconPolymer™	List	Each	6 +
Whole	338.34	253.73	202.99	
Split in Half (Pilaster)	374.46	280.84	224.68	
Whole White Painted	457.43	343.07	274.46	
Split in Half White Painted	493.58	370.18	296.15	

ITEM 2

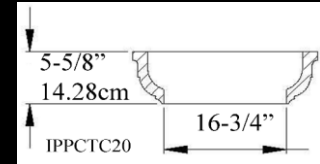
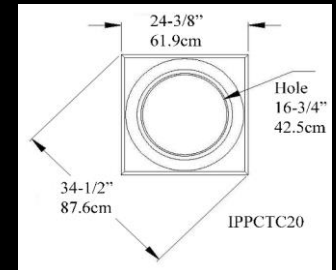

[click for Brochure/Order Form](#)

Cap (EconPolymer)



IPDC20	Hole 17-1/2"			
	FRP-PolyComp™	List	Each	6 +
Whole	876.13	856.86	876.13	
Split for Post Wrap	982.36	960.75	982.36	
Split in Half (Pilaster)	986.83	965.12	986.83	

ITEM 9

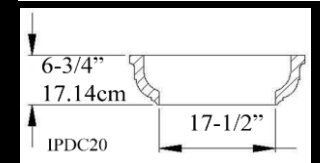
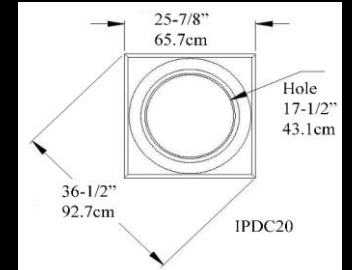

[click for Brochure/Order Form](#)



IPDC22	Hole 19"			
	FRP-PolyComp™	List	Each	6 +
Whole	1021.71	999.24	1021.71	
Split for Post Wrap	1127.95	1103.13	1127.95	
Split in Half (Pilaster)	1133.07	1108.14	1133.07	

ITEM 9

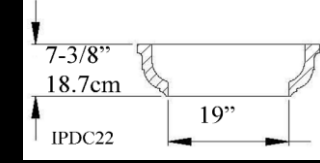
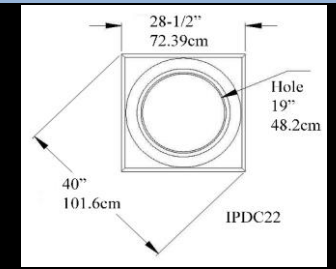

[click for Brochure/Order Form](#)





IPPCTC24	Hole 20-1/2"		
EconPolymer™	List	Each	6 +
Whole	<del>792.85</del>	594.64	475.71
Split in Half (Pilaster)	<del>839.90</del>	629.92	503.94
Whole White Painted	<del>946.80</del>	710.10	568.08
Split in Half White Painted	<del>993.82</del>	745.37	596.29

ITEM 2

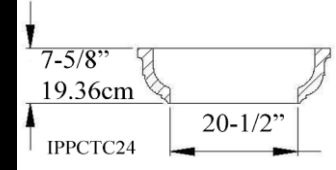
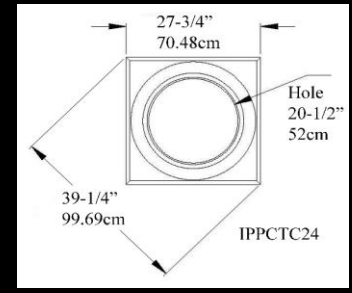

Cap (EconPolymer)

[click for Brochure/Order Form](#)

IPDC24	Hole 20-1/2"		
FRP-PolyComp™	List	Each	6 +
Whole	<del>1214.94</del>	1188.21	1214.94
Split for Post Wrap	<del>1321.17</del>	1292.11	1321.17
Split in Half (Pilaster)	<del>1327.18</del>	1297.98	1327.18

ITEM 9

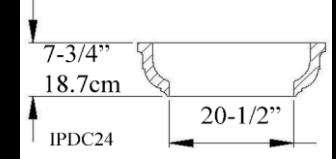
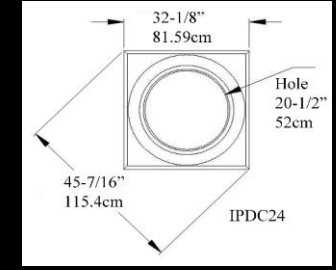

[click for Brochure/Order Form](#)

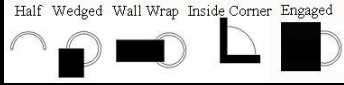

IPDC30	Hole 27-1/2"		
FRP-PolyComp™	List	Each	6 +
Whole	<del>1574.22</del>	1539.58	1574.22
Split for Post Wrap	<del>1680.45</del>	1643.48	1680.45
Split in Half (Pilaster)	<del>1688.09</del>	1650.95	1688.09

ITEM 9

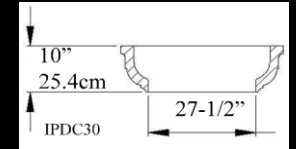
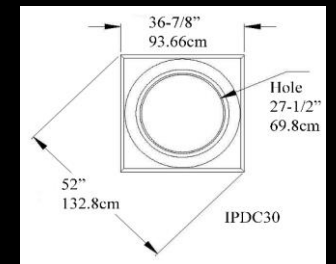

[click for Brochure/Order Form](#)





# Doric Capital - Custom Form

## Hardwood or Composite

D=Top Square Height ----->

E=Mid Square Height ----->

F=Ovolo Round Height ----->

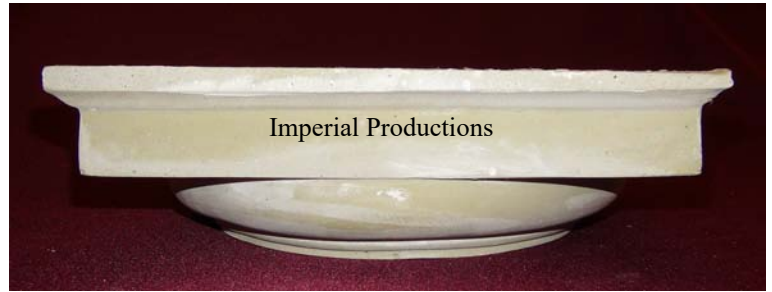

G=Ovolo Diameter Outside

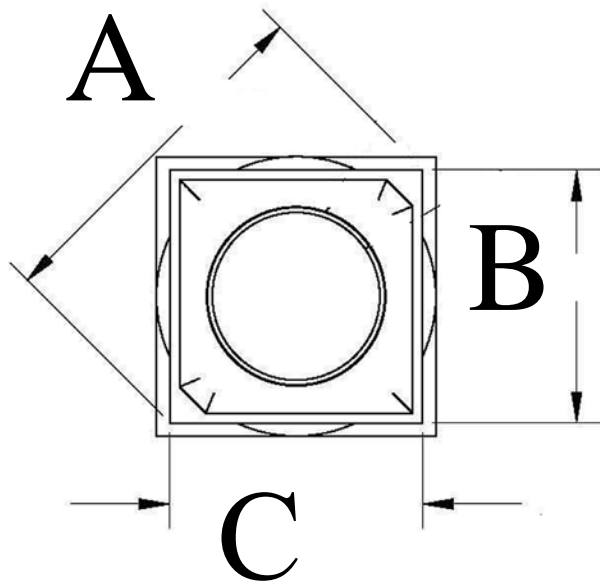

A = \_\_\_\_\_

B = \_\_\_\_\_

C = \_\_\_\_\_

D = \_\_\_\_\_

E = \_\_\_\_\_

F = \_\_\_\_\_

G = \_\_\_\_\_

TAG NAME

---

\* All specifications subject to change without notice, Final products & Measurements may vary from this brochure



**Imperial Productions®**

1-800-399-7585

Imperial Productions & Distribution Inc Toronto / New York

email sales@imperialproductions.com copyright 2016 MRDCI All Rights Reserved

MAY-21





# Imperial Productions® Request for Quote

Download, Fill-in & Email to [sales@imperialproductions.com](mailto:sales@imperialproductions.com)

Name / Company: \_\_\_\_\_

Phone \_\_\_\_\_ Email \_\_\_\_\_

Billing Address: \_\_\_\_\_

City: \_\_\_\_\_ Prov / State \_\_\_\_\_

PC / Zip Code \_\_\_\_\_

Ship to Address: \_\_\_\_\_

City: \_\_\_\_\_ Prov / State \_\_\_\_\_

PC / Zip Code \_\_\_\_\_

Product Code: \_\_\_\_\_

Quantity: \_\_\_\_\_

Notes: \_\_\_\_\_



Imperial Productions®

1-800-399-7585

Imperial Productions & Distribution Inc Toronto / New York

email [sales@imperialproductions.com](mailto:sales@imperialproductions.com) copyright 2016 MRDCI All Rights Reserved