



# 10 Feet (3.048 m)

Specify for Post Wraps around load bearing supports or stand alone columns as room dividers & entrances

**Best Material for Exteriors:**

Load Bearing PolyComp™, FiberComp™ or Solid Core White Oak

Decorative: ArchPolymer™, 24 Hardwoods, Composites



<b>IPAPNT1006P-TCTB</b>	<b>10 Feet 6" NonTapered</b>		
<b>ArchPolymer™</b>	List	Each	6 +
Split for Reassembly	<b>455.44</b>	<b>341.58</b>	<b>273.27</b>
Load Bearing 4-1/2" Steel Post Inbedded	call for pricing		
Fire Rated in the Material	call for pricing		

**ITEM 10-1** CAPITAL Square 9-1/2" x 9-1/2" x 2-1/2" (24.1 x 24.1 x 6.35cm)  
 SHAFT Top & Bottom Shaft O/D 6" (15.2cm)  
 Inside Diameter 3-1/2" (8.8cm)  
 BASE Square 9-1/2" x 9-1/2" x 4-3/4" (24.1 x 24.1 x 12cm)

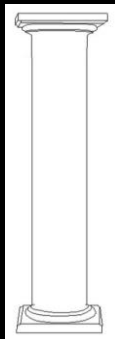

Cap (ArchPolymer)

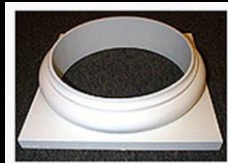

Base (ArchPolymer)

[click for Drawing / Order Form](#)

<b>IPTUS1008S-TCTB</b>	<b>10 Feet 7-5/8" Tapered</b>		
<b>FRP-FiberComp™</b>	List	Each	6 +
Whole	<b>498.86</b>	<b>374.14</b>	<b>299.31</b>
Split for Post Wrap	<b>649.94</b>	<b>487.43</b>	<b>389.95</b>
Split in Half (Pilaster)	<b>649.94</b>	<b>487.43</b>	<b>389.95</b>
Cut to Height	<b>52.94</b>	<b>39.70</b>	<b>31.76</b>
Split Kit	<b>130.05</b>	<b>97.54</b>	<b>78.03</b>

**ITEM 10-2**

Capital IP1C8: 9" (22.8cm) square, Hole Fits 6-1/2" (16.5cm), Height 2-5/8" (6.6cm), Overall Height 12-3/4" (32.38cm).

Base IPTB8: 10-1/4" (26cm) square, Fits 7-7/8" (19.3cm) Shaft, Height 4" (10cm), Overall Height 14-1/2" (36.8cm).

Total Height 10 Feet (120") (3.048m)  
 Centered Load Bearing to 10,000lbs (4.535 mtons)  
 Top of Shaft O/D 6-1/4" (15.8cm)  
 I/D 5" (12.7cm)  
 Bottom of Shaft O/D 7-5/8" (19.36cm)  
 Tuscan Base - Hollow  
 IPTUS1008S-TCTB



[click for Drawing / Order Form](#)

Custom Tapered PDF Form Composite

<b>IPPC1008S-TBTC</b>	<b>10 Feet 7-5/8" Tapered</b>		
<b>FRP-PolyComp™</b>	List	Each	6 +
Whole	<b>480.14</b>	<b>360.08</b>	<b>288.06</b>
Split in Half (Pilaster)	<b>580.72</b>	<b>435.54</b>	<b>348.43</b>
Whole White Painted	<b>815.36</b>	<b>611.52</b>	<b>489.21</b>
Split in Half White Painted	<b>916.06</b>	<b>687.04</b>	<b>549.63</b>

**ITEM 10-3**

Capital IPPCTC08: 9-1/8" (23.17cm) square, Hole Fits 6-1/4" (15.8cm), Height 2-1/2" (6.35cm), Overall Height 13" (33cm).

Base IPPCTB08: 14" (35.5cm) square, Hole Fits 7-11/16" (19.5cm), Height 4-1/8" (10.4cm), Overall Height 10" (25.4cm).

Total Height 10 Feet (120") (3.048m)  
 Centered Load Bearing to 10,000lbs (4.535 mtons)  
 Top of Shaft O/D 6-1/8" (15.5cm)  
 I/D 5-3/8" (13.6cm)  
 Bottom of Shaft O/D 7-5/8" (19.36cm)  
 Tuscan Base - Hollow  
 IPPC1008S-TBTC

[click for Drawing / Order Form](#)



IPPC1008SNT-TBTC	10FT 7-5/8" Non-Tapered		
<b>FRP-PolyComp™</b>	List	Each	6 +
Whole	480.11	360.08	288.06
Split in Half (Pilaster)	582.04	436.53	349.22
Whole White Painted	828.69	621.51	497.21
Split in Half White Painted	752.95	564.71	451.77

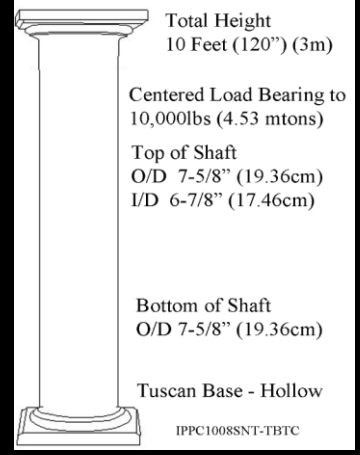
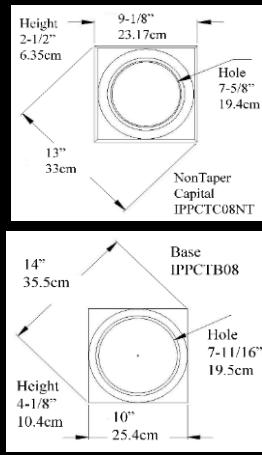

[click for Drawing / Order Form](#)

IPTUS1008SNT-TCTB	10 Feet 7-3/4" Non-Tapered		
<b>FRP-FiberComp™</b>	List	Each	6 +
Whole	568.74	426.55	341.24
Split for Post Wrap	719.79	539.84	431.87
Split in Half (Pilaster)	719.79	539.84	431.87
Cut to Height	52.94	39.70	31.76
Split Kit	130.05	97.54	78.03

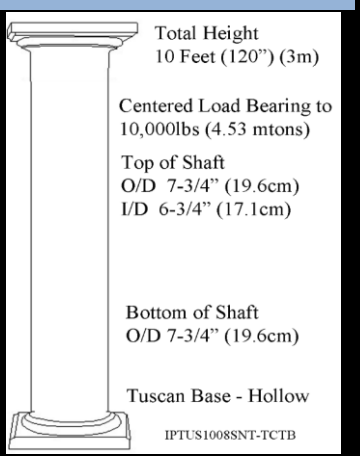
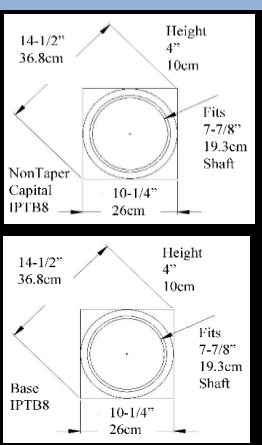

[click for Drawing / Order Form](#)



[Custom NonTaper PDF Form Composite](#)

IPAP1008P-TCTB	10 Feet 8" Tapered		
<b>ArchPolymer™</b>	List	Each	6 +
Split for Reassembly	462.09	462.09	369.68
Load Bearing 4-1/2" Steel Post Inbedded	call for pricing		
Fire Rated in the Material	call for pricing		

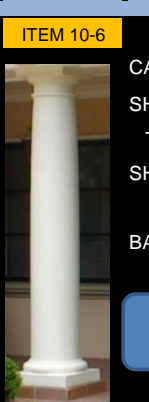

CAPITAL Square 9-1/2" x 9-1/2" x 2-1/2" (24 x 24 x 6.3cm)  
 SHAFT Top O/D 6" (15.24cm)  
 Top Inside Diameter 3" (7.62cm)  
 SHAFT Bottom 8" (20.32cm)  
 BASE Square 11-1/2" x 11-1/2" x 5-1/4" (29.2 x 29.2 x 13.3cm)

[click for Drawing / Order Form](#)

[Custom Tapered PDF Form Composite](#)

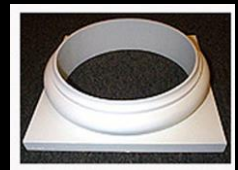

Cap (ArchPolymer)

Base (ArchPolymer)

IPC1008P-TCTB	10 Feet 8" Tapered		
<b>Interior Hardwood</b>	List	Each	6 +
Poplar (Paint Grade)	752.40	564.30	451.44
Maple, Bass, Ash, Yellow Birch	1090.98	818.24	654.59
Sap Maple	1241.46	931.10	744.88
Beech	1241.46	931.10	744.88
Alder	1369.37	1027.03	821.62
Red Oak, African Mahogany	1241.46	931.10	744.88
Cherry	1354.32	1015.74	812.59
<b>Exterior Hardwood</b>			
White Oak, White Pine, Cedar	1542.42	1156.82	925.45
Knotty Pine	940.50	705.38	564.30
Clear Pine	1241.46	931.10	744.88

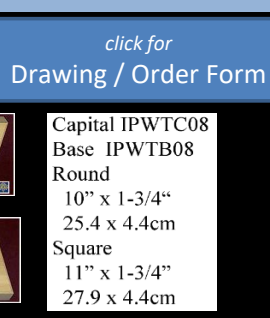

[click for Drawing / Order Form](#)



[Custom HW Taper Form](#)



IPCNT1008P-TCTB 10 Feet 8" Non-Tapered			
Interior Hardwood	List	Each	6 +
Poplar (Paint Grade)	1028.28	771.21	616.97
Maple, Bass, Ash, Yellow Birch	1491.01	1118.25	894.60
Sap Maple	1696.66	1272.50	1018.00
Beech	1696.66	1272.50	1018.00
Alder	1871.47	1403.60	1122.88
Red Oak, African Mahogany	1696.66	1272.50	1018.00
Cherry	1850.90	1388.18	1110.54
Exterior Hardwood			
White Oak, White Pine, Cedar	2107.97	1580.98	1264.78
Knotty Pine	1285.35	964.01	771.21
Clear Pine	1696.66	1272.50	1018.00

ITEM 10-8

[click for Drawing / Order Form](#)

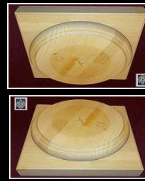

Capital IPWTC08  
Base IPWTB08  
Round  
10" x 1-3/4"  
25.4 x 4.4cm  
Square  
11" x 1-3/4"  
27.9 x 4.4cm



Custom HW NonTaper Form



Total Height  
10 Feet (120") (3.048m)  
Smooth Non-Tapered  
Decorative  
Top of Shaft  
O/D 8" (20.3cm)  
I/D 5" (12.7cm)  
Bottom of Shaft  
O/D 8" (20.3cm)  
Options:  
Solid Core for Load  
Split in Half / Wedged  
Inside or Outside Corners

IPCNT1008P-TCTB

IPAPNT1008P-TCTB 10 Feet 8" NonTapered			
ArchPolymer™	List	Each	6 +
Split for Reassembly	589.24	441.93	353.54
Load Bearing 4-1/2" Steel Post Inbedded	call for pricing		
Fire Rated in the Material	call for pricing		

ITEM 10-9

CAPITAL Square 11" x 11" x 3-1/4" (27.9 x 27.9 x 8.2cm)  
SHAFT Top & Bottom of Shaft O/D 8" (20.3cm)  
Inside Diameter 5-1/2" (13.9cm)  
BASE Square 11" x 11" x 3-1/4" (27.9 x 27.9 x 8.2cm)

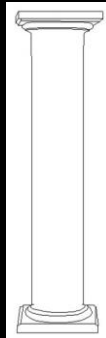

[click for Drawing / Order Form](#)

Custom HW NonTaper Form



Cap (ArchPolymer)

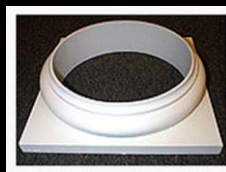

Base (ArchPolymer)

IPTUS1010S-TCTB 10 Feet 9-5/8" Tapered			
FRP-FiberComp™	List	Each	6 +
Whole	631.29	473.47	378.78
Split for Post Wrap	785.78	589.33	471.47
Split in Half (Pilaster)	785.78	589.33	471.47
Cut to Height	54.14	40.61	32.49
Split Kit	133.01	99.76	79.80

ITEM 10-10

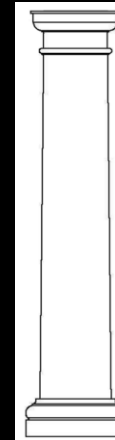
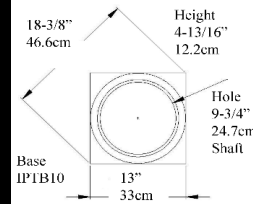
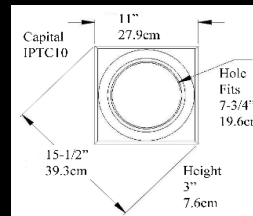

Total Height  
10 Feet (120") (3.048m)  
Centered Load Bearing to  
14,000lbs (6.35 mtons)  
Top of Shaft  
O/D 7-1/2" (19cm)  
I/D 6-1/4" (15.8cm)  
Bottom of Shaft  
O/D 9-5/8" (24.4cm)  
Tuscan Base - Hollow  
IPTUS1010S-TCTB



Custom Tapered PDF Form Composite

[click for Drawing / Order Form](#)

IPPC1010S-TBTC 10 Feet 9-5/8" Tapered			
FRP-PolyComp™	List	Each	6 +
Whole	603.63	452.72	362.18
Split in Half (Pilaster)	709.91	532.43	425.95
Whole White Painted	1040.12	780.09	624.07
Split in Half White Painted	1146.46	859.84	687.88

ITEM 10-11

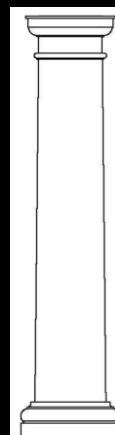
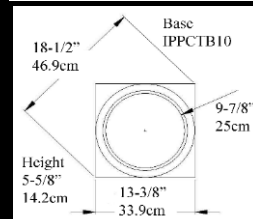
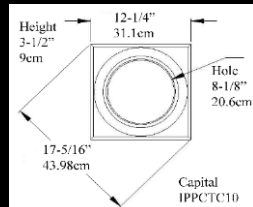

Total Height  
10 Feet (120") (3.048m)  
Centered Load Bearing to  
14,000lbs (6.35 mtons)  
Top of Shaft  
O/D 8" (20.3cm)  
I/D 7-1/4" (18.4cm)  
Bottom of Shaft  
O/D 9-5/8" (24.4cm)  
Tuscan Base - Hollow  
IPPC1010S-TBTC

[click for Drawing / Order Form](#)



IPPC1010SNT-TBTC	10 Feet 9-5/8" Non-Tapered		
<b>FRP-PolyComp™</b>	List	Each	6 +
Whole	603.63	452.72	362.18
Split in Half (Pilaster)	709.94	532.45	425.96
Whole White Painted	1070.61	802.96	642.37
Split in Half White Painted	941.00	705.75	564.60

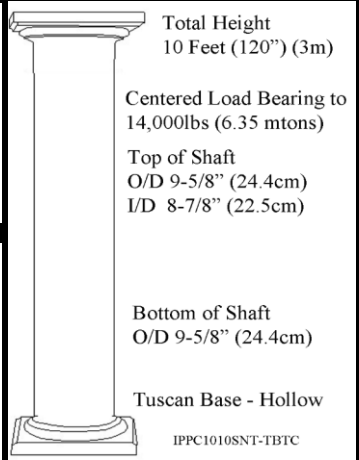
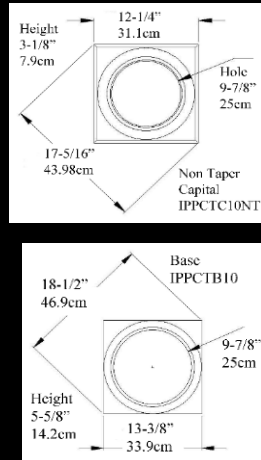
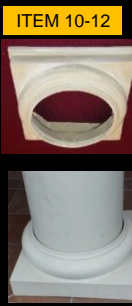

[click for Drawing / Order Form](#)

IPTUS1010SNT-TCTB	10 Feet 9-3/4" Non-Tapered		
<b>FRP-FiberComp™</b>	List	Each	6 +
Whole	742.73	557.05	445.64
Split for Post Wrap	893.78	670.34	536.27
Split in Half (Pilaster)	893.78	670.34	536.27
Cut to Height	52.94	39.70	31.76
Split Kit	130.05	97.54	78.03

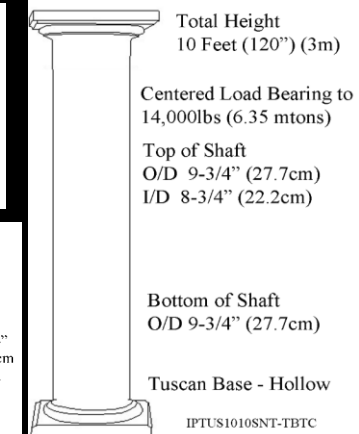
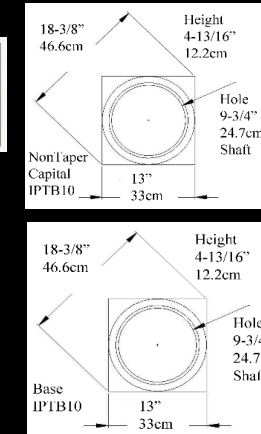

[Custom NonTaper PDF Form Composite](#)

[click for Drawing / Order Form](#)



IPC1010P-TCTB	10 Feet 10" Tapered		
<b>Interior Hardwood</b>	List	Each	6 +
Poplar (Paint Grade)	1028.28	771.21	616.97
Maple, Bass, Ash, Yellow Birch	1491.01	1118.25	894.60
Sap Maple	1696.66	1272.50	1018.00
Beech	1696.66	1272.50	1018.00
Alder	1871.47	1403.60	1122.88
Red Oak, African Mahogany	1696.66	1272.50	1018.00
Cherry	1850.90	1388.18	1110.54
<b>Exterior Hardwood</b>			
White Oak, White Pine, Cedar	2107.97	1580.98	1264.78
Knotty Pine	1285.35	964.01	771.21
Clear Pine	1696.66	1272.50	1018.00

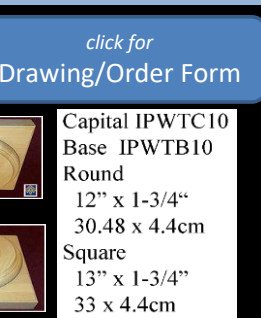

[click for Drawing/Order Form](#)

[Custom HW Taper Form](#)

IPCNT1010P-TCTB	10 Feet 10" Non-Tapered		
<b>Interior Hardwood</b>	List	Each	6 +
Poplar (Paint Grade)	1605.12	1203.84	963.07
Maple, Bass, Ash, Yellow Birch	2327.42	1745.57	1396.45
Sap Maple	2648.45	1986.34	1589.07
Beech	2648.45	1986.34	1589.07
Alder	2921.32	2190.99	1752.79
Red Oak, African Mahogany	2648.45	1986.34	1589.07
Cherry	2889.22	2166.91	1733.53
<b>Exterior Hardwood</b>			
White Oak, White Pine, Cedar	3290.50	2467.87	1974.30
Knotty Pine	2006.40	1504.80	1203.84
Clear Pine	2648.45	1986.34	1589.07

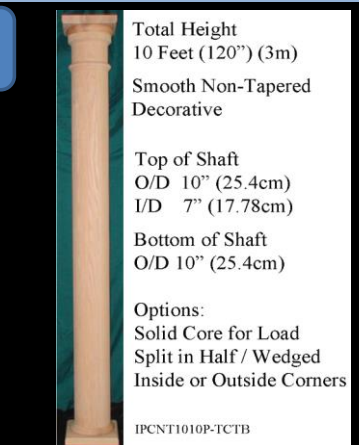
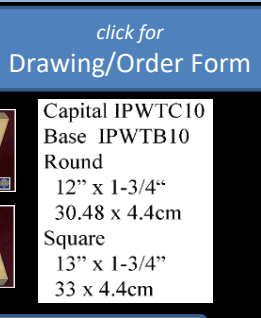

[click for Drawing/Order Form](#)

[Custom HW NonTaper Form](#)



**IP1010-TCTB 10 Feet 10" Tapered**

**ITEM 10-16** CAPITAL Square 12-1/2" x 12-1/2" (63.5 x 63.5cm)

StoneMold™

Zeament™

call



SHAFT Top of Shaft O/D 8-1/2" (21.6cm)  
Taper ends 2/3rds to the Bottom of Shaft  
Bottom Shaft O/D 10" (25.4cm)  
BASE Square 13-3/8" x 13-3/8" x 5-1/4" (33.9 x 33.9 x 13.3cm)

[click for Drawing / Order Form](#)

Decorative only - Seam Remains as a Reveal for post wrap

**IPAP1010P-TCTB 10 Feet 10" Tapered**

**ITEM 10-17** CAPITAL Square 11-1/2" x 11-1/2" x 2-3/4" (29.2 x 29.2 x 6.9cm)

ArchPolymer™	List	Each	6 +
Split for Reassembly	773.07	579.81	463.84
Load Bearing 4-1/2" Steel Post Inbedded	call for pricing		
Fire Rated in the Material	call for pricing		



SHAFT Top O/D 8" (20.3cm) Shaft split for post wrap  
Inside Diameter 5" (12.7 cm)  
Bottom 10" (25.4cm)  
BASE Square 13-3/4" x 13-3/4" x 5-3/4" (34.9 x 34.9 x 14.6cm)  
Decorative only

[click for Drawing / Order Form](#)



Cap (ArchPolymer)

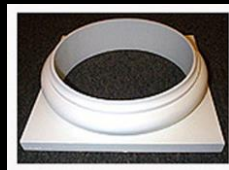

Base (ArchPolymer)

**IPAPNT1010P-TCTB 10 Feet 10" NonTapered**

**ITEM 10-18** CAPITAL Square 13-3/4" x 13-3/4" x 5-3/4" (34.9 x 34.9 x 14.6cm)

ArchPolymer™	List	Each	6 +
Split for Reassembly	788.60	591.45	473.16
Load Bearing 4-1/2" Steel Post Inbedded	call for pricing		
Fire Rated in the Material	call for pricing		

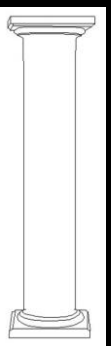

SHAFT Top of Shaft O/D 10" (25.4cm)  
Inside Diameter 7-1/2" (19cm)  
SHAFT Bottom O/D 10" (25.4cm)  
BASE Square 13" x 13" x 4-1/2" (33 x 33 x 11.4cm)

[click for Drawing / Order Form](#)

[Custom NonTaper PDF Form Composite](#)



Cap (ArchPolymer)

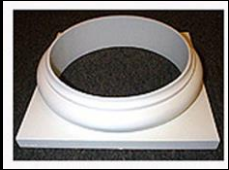

Base (ArchPolymer)

**IPPC1012S-TBTC 10 Feet 11-1/2" Tapered**

**ITEM 10-19**

FRP-PolyComp™	List	Each	6 +
Whole	822.05	616.54	493.23
Split in Half (Pilaster)	935.73	701.80	561.44
Whole White Painted	1414.76	1061.07	848.85
Split in Half White Painted	1528.41	1146.31	917.05

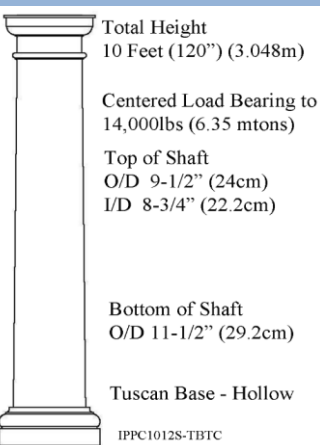
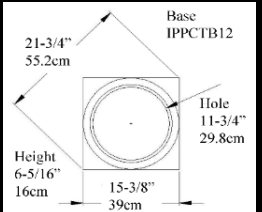
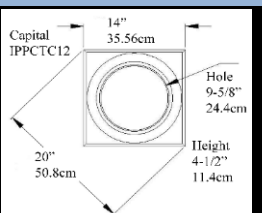

[click for Drawing / Order Form](#)



IPTUS1012S-TCTB		10 Feet 11-5/8" Tapered	
FRP-FiberComp™	List	Each	6 +
Whole	880.55	660.41	528.33
Split for Post Wrap	1031.60	773.70	618.96
Split in Half (Pilaster)	1031.60	773.70	618.96
Cut to Height	52.94	39.70	31.76
Split Kit	130.05	97.54	78.03

ITEM 10-20

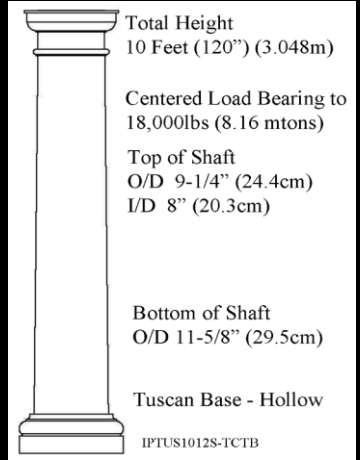
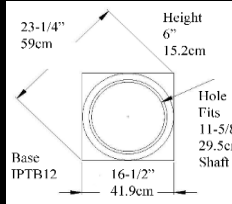
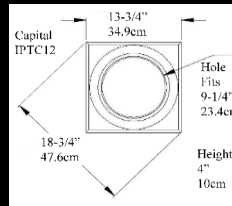

Custom Tapered PDF Form Composite



[click for Drawing / Order Form](#)

IPPC1012SNT-TBTC		10 Feet 11-3/4" Non-Tapered	
FRP-PolyComp™	List	Each	6 +
Whole	822.11	616.58	493.26
Split in Half (Pilaster)	935.73	701.80	561.44
Whole White Painted	1441.87	1081.40	865.12
Split in Half White Painted	1227.08	920.31	736.25

ITEM 10-21

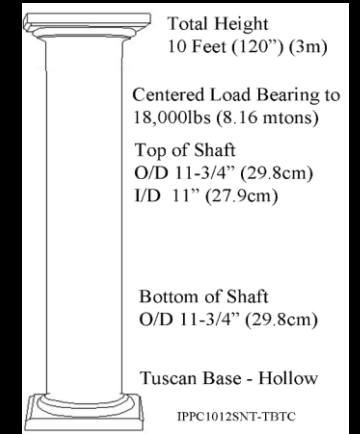
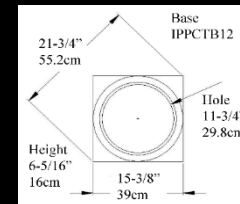
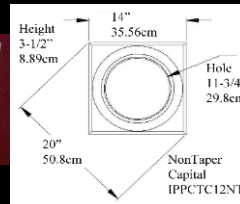
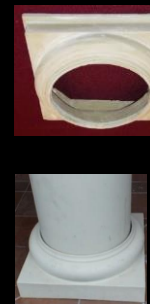

[click for Drawing / Order Form](#)

IPTUS1012SNT-TCTB		10 Feet 11-3/4" Non-Tapered	
FRP-FiberComp™	List	Each	6 +
Whole	880.55	660.41	528.33
Split for Post Wrap	1031.60	773.70	618.96
Split in Half (Pilaster)	1031.60	773.70	618.96
Cut to Height	52.94	39.70	31.76
Split Kit	130.05	97.54	78.03

ITEM 10-22

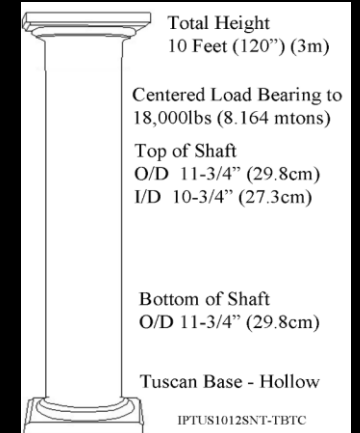
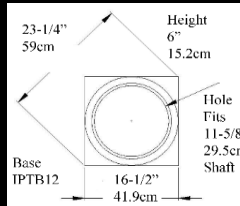
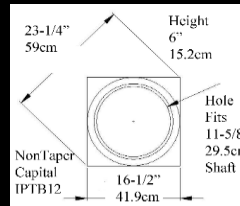

Custom NonTaper PDF Form Composite



[click for Drawing / Order Form](#)

IPC1012P-TCTB		10 Feet 12" Tapered	
Interior Hardwood	List	Each	6 +
Poplar (Paint Grade)	1605.12	1203.84	963.07
Maple, Bass, Ash, Yellow Birch	2327.42	1745.57	1396.45
Sap Maple	2648.45	1986.34	1589.07
Beech	2648.45	1986.34	1589.07
Alder	2921.32	2190.99	1752.79
Red Oak, African Mahogany	2648.45	1986.34	1589.07
Cherry	2889.22	2166.91	1733.53
Exterior Hardwood			
White Oak, White Pine, Cedar	3290.50	2467.87	1974.30
Knotty Pine	2006.40	1504.80	1203.84
Clear Pine	2648.45	1986.34	1589.07

ITEM 10-23



[click for Drawing/Order Form](#)

Capital IPWTC12  
Base IPWTB12  
Round  
14" x 1-3/4"  
35.5 x 4.4cm  
Square  
15" x 1-3/4"  
38 x 4.4cm

Custom HW Taper Form





IPCNT1012P-TCTB 10 Feet 12" Non-Tapered			
Interior Hardwood	List	Each	6 +
Poplar (Paint Grade)	2006.40	1504.80	1203.84
Maple, Bass, Ash, Yellow Birch	2909.28	2181.96	1745.57
Sap Maple	3310.56	2482.92	1986.34
Beech	3310.56	2482.92	1986.34
Alder	3651.65	2738.74	2190.99
Red Oak, African Mahogany	3310.56	2482.92	1986.34
Cherry	3611.52	2708.64	2166.91
Exterior Hardwood			
White Oak, White Pine, Cedar	4113.12	3084.84	2467.87
Knotty Pine	2508.00	1881.00	1504.80
Clear Pine	3310.56	2482.92	1986.34

ITEM 10-24

[click for Drawing/Order Form](#)

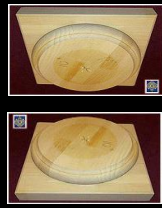

Capital IPWTC12  
Base IPWTB12  
Round  
14" x 1-3/4"  
35.5 x 4.4cm  
Square  
15" x 1-3/4"  
38 x 4.4cm

[Custom HW NonTaper Form](#)



Total Height  
10 Feet (120") (3.048m)  
Smooth Non-Tapered  
Decorative  
Top of Shaft  
O/D 12" (30.48cm)  
I/D 11" (27.9cm)  
Bottom of Shaft  
O/D 12" (30.48cm)  
Options:  
Solid Core for Load  
Split in Half / Wedged  
Inside or Outside Corners  
IPCNT1012P-TCTB

IPAP1012P-TCTB 10 Feet 12" Tapered			
ArchPolymer™	List	Each	6 +
Split for Reassembly	738.44	590.75	571.06
Load Bearing 4-1/2" Steel Post Inbedded	call for pricing		
Fire Rated in the Material	call for pricing		

ITEM 10-25

CAPITAL Square 13-3/4" x 13-3/4" x 5-3/4" (34.9 x 34.9 x 26cm)  
SHAFT Top O/D 10" (25.4cm) Shaft split for post wrap  
Inside Diameter 7" (17.78 cm)  
Bottom 12" (30.48cm)  
BASE Square 15-3/4" x 15-3/4" x 6-1/4" (40 x 40 x 15.8cm)  
Decorative only



Cap (ArchPolymer)

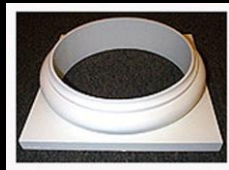

Base (ArchPolymer)



[click for Drawing / Order Form](#)

IPAPNT1012P-TCTB 10 Feet 12" NonTapered			
ArchPolymer™	List	Each	6 +
Split for Reassembly	939.75	704.81	563.85
Load Bearing 4-1/2" Steel Post Inbedded	call for pricing		
Fire Rated in the Material	call for pricing		

ITEM 10-26

CAPITAL Square 15" x 15" x 3-1/4" (38 x 38 x 8.2cm)  
SHAFT Top & Bottom O/D 12" (30.48cm)  
Inside Diameter 9-1/2" (24cm)  
Decorative - not load bearing  
BASE Square 15" x 15" x 3-1/4" (38 x 38 x 8.2cm)



Cap (ArchPolymer)



Base (ArchPolymer)

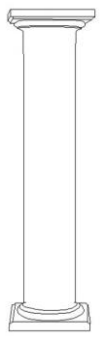

[click for Drawing / Order Form](#)

[Custom NonTaper PDF Form Composite](#)

IPT1012-TCTB 10 Feet 12" Tapered			
StoneMold™	Zeament™	call	

ITEM 10-27

CAPITAL Square 15-1/2" x 15-1/2" (39.4 x 39.4cm)  
Round call  
SHAFT Top of Shaft O/D 10" (25.4cm) Inside call  
Taper ends 2/3rds down Shaft  
Bottom Shaft O/D 12" (30.5cm)  
BASE Square 16-3/4" x 16-3/4" (42.5 x 42.5cm)



[click for Drawing / Order Form](#)

Decorative only - Seam Remains as a Reveal for post wrap



IPTUS1014S-TCTB 10 Feet 13-5/8" Tapered			
FRP-FiberComp™	List	Each	6 +
Whole	1704.62	1278.47	1022.77
Split for Post Wrap	1855.67	1391.76	1113.40
Split in Half (Pilaster)	1855.67	1391.76	1113.40
Cut to Height	52.94	39.70	31.76
Split Kit	130.05	97.54	78.03

ITEM 10-28

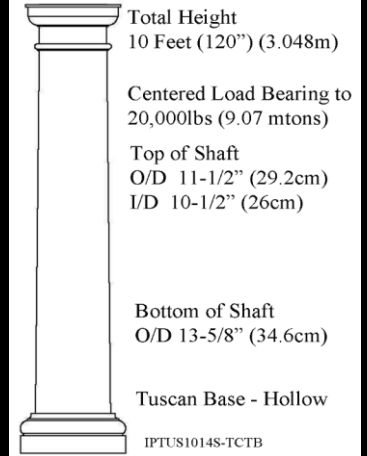
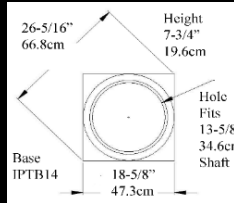
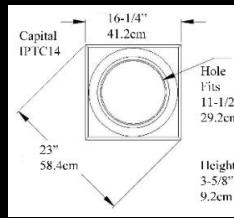

click for Drawing/Order Form

Custom Tapered PDF Form Composite

IPTUS1014SNT-TCTB 10 Feet 13-5/8" Non-Tapered			
Fiberglass	List	Each	6 +
Whole	2226.24	1669.68	1335.75
Split for Post Wrap	2268.60	1701.45	1361.16
Split in Half (Pilaster)	2268.60	1701.45	1361.16
Cut to Height	52.94	39.70	31.76
Split Kit	130.05	97.54	78.03

ITEM 10-29

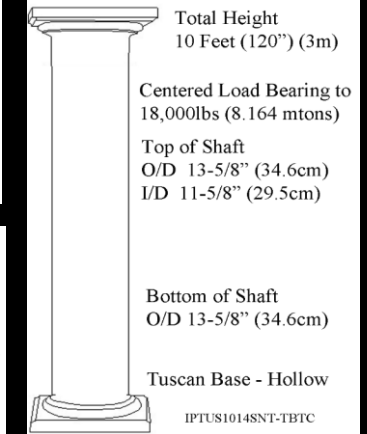
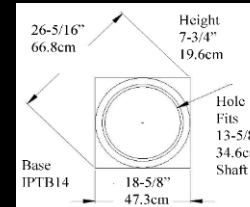
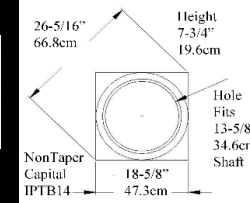

click for Drawing / Order Form

Custom NonTaper PDF Form Composite

IPPC1014SNT-TBTC 10 Feet 13-3/4" Non-Tapered			
FRP-PolyComp™	List	Each	6 +
Whole	1666.12	1249.59	999.67
Split in Half (Pilaster)	1789.19	1341.89	1073.51
Whole White Painted	2394.51	1795.88	1436.70
Split in Half White Painted	1969.45	1477.09	1181.67

ITEM 10-30

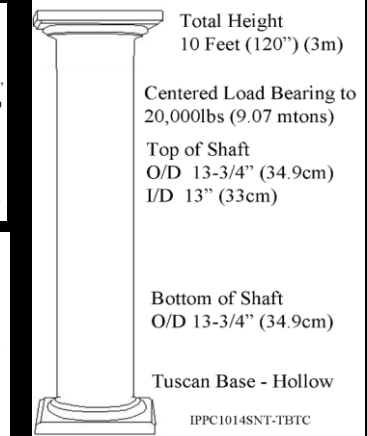
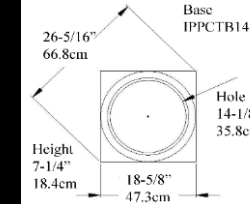
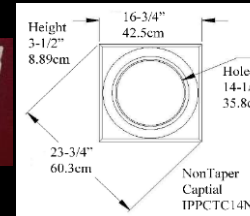

click for Drawing / Order Form

IPPC1014S-TBTC 10 Feet 13-7/8" Tapered			
FRP-PolyComp™	List	Each	6 +
Whole	1666.09	1249.57	999.66
Split in Half (Pilaster)	1789.19	1341.89	1073.51
Whole White Painted	2351.26	1763.45	1410.76
Split in Half White Painted	2474.36	1855.77	1484.61

ITEM 10-31

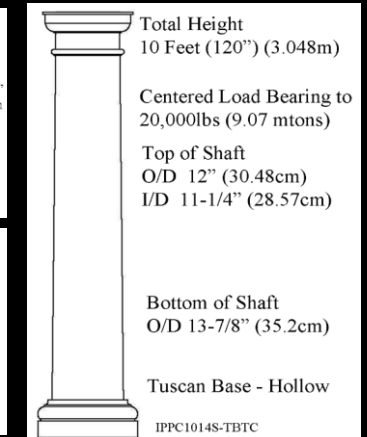
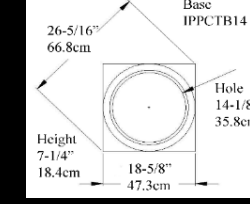
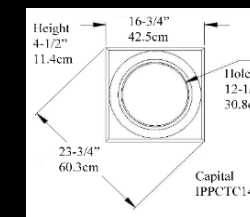

click for Drawing / Order Form





IPAP1014P-TCTB 10 Feet 14" Tapered			
ArchPolymer™	List	Each	6 +
Split for Reassembly	1143.09	857.32	685.85
Load Bearing 4-1/2" Steel Post Inbedded	call for pricing		
Fire Rated in the Material	call for pricing		



Cap (ArchPolymer)

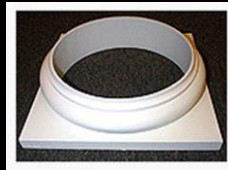

Base (ArchPolymer)

**ITEM 10-32** CAPITAL Square 15-3/4" x 15-3/4" x 3-1/2" (40 x 40 x 8.9cm)  
 SHAFT Top O/D 12" (30.48cm) Shaft split for post wrap  
 Inside Diameter 9" (22.86 cm)  
 Bottom 14" (35.56cm)  
 BASE Square 18-3/4" x 18-3/4" x 6-3/4" (47.6 x 47.6 x 17cm)  
 Decorative only



[click for Drawing / Order Form](#)

IPAPNT1014P-TCTB 10 Feet 14" NonTapered			
ArchPolymer™	List	Each	6 +
Split for Reassembly	1127.74	845.78	676.63
Load Bearing 4-1/2" Steel Post Inbedded	call for pricing		
Fire Rated in the Material	call for pricing		



Cap (ArchPolymer)

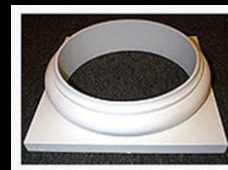

Base (ArchPolymer)

**ITEM 10-33** CAPITAL Square 18-3/4" x 18-3/4" x 4" (47.6 x 47.6 x 10cm)  
 SHAFT Top & Bottom O/D 14" (35.8cm)  
 Inside Diameter 10-1/4" (26cm)  
 Decorative - not load bearing  
 BASE Square 18-3/4" x 18-3/4" x 6-3/4" (47.6 x 47.6 x 17cm)

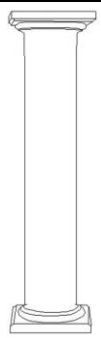

[click for Drawing / Order Form](#)

[Custom NonTaper PDF Form Composite](#)

IPTUS1016S-TCTB 10 Feet 15-1/2" Tapered			
FRP-FiberComp™	List	Each	6 +
Whole	2248.30	1686.23	1348.98
Split for Post Wrap	2493.23	1869.92	1495.94
Split in Half (Pilaster)	2493.23	1869.92	1495.94
Cut to Height	52.94	39.70	31.76
Split Kit	130.05	97.54	78.03



[Custom Tapered PDF Form Composite](#)

[click for Drawing / Order Form](#)

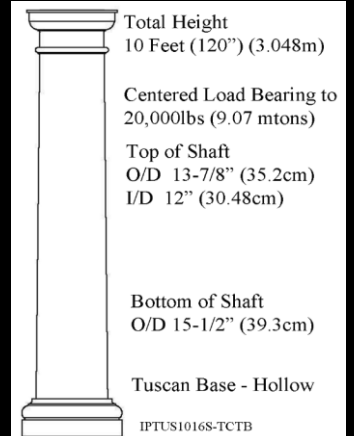
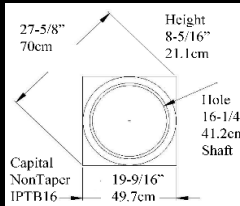
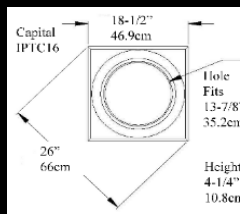

IPTUS1016SNT-TCTB 10 Feet 15-1/2" Non-Tapered			
Fiberglass	List	Each	6 +
Whole	2841.57	2131.18	1704.94
Split for Post Wrap	2977.80	2233.35	1786.68
Split in Half (Pilaster)	2977.80	2233.35	1786.68
Cut to Height	52.94	39.70	31.76
Split Kit	130.05	97.54	78.03



[Custom NonTaper PDF Form Composite](#)

[click for Drawing / Order Form](#)

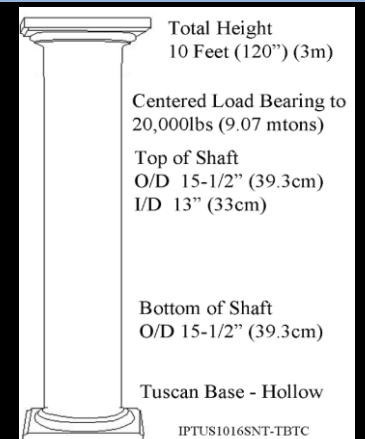
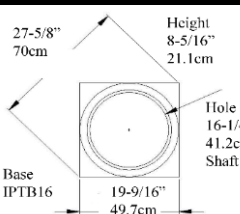
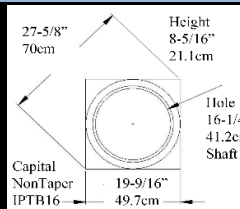



IPPC1016S-TBTC	10 Feet 15-3/4" Tapered		
FRP-PolyComp™	List	Each	6 +
Whole	2320.95	1740.71	1392.57
Split in Half (Pilaster)	2588.47	1941.35	1553.08
Whole White Painted	3104.84	2328.63	1862.91
Split in Half White Painted	3372.40	2529.30	2023.44

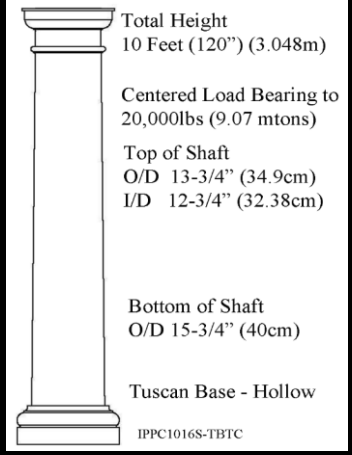
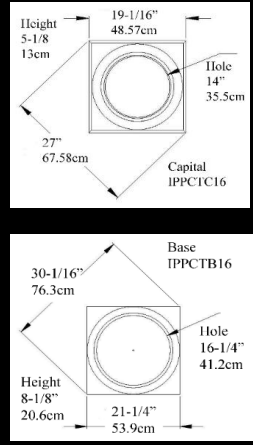

[click for Drawing / Order Form](#)

IPAP1016P-TCTB	10 Feet 16" Tapered		
ArchPolymer™	List	Each	6 +
Split for Reassembly	1396.89	1047.67	822.49
Load Bearing Post Inbedded	call for pricing		
Fire Rated in the Material	call for pricing		



**ITEM 10-37**  
 CAPITAL Square 18-3/4" x 18-3/4" x 4" (47.6 x 47.6 x 10cm)  
 SHAFT Top O/D 14" (35.5cm) Shaft split for post wrap  
 Inside Diameter 11" (27.9cm)  
 Bottom 16" (44.64 cm)  
 BASE Square 20-3/4" x 20-3/4" x 7-1/4" (52.7 x 52.7 x 18.4cm)  
 Decorative only

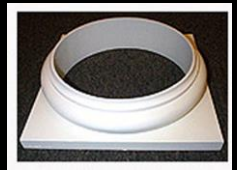

Cap (ArchPolymer)

Base (ArchPolymer)

[click for Drawing / Order Form](#)

[Custom Tapered PDF Form Composite](#)

IPAPNT1016P-TCTB	10 Feet 16" NonTapered		
ArchPolymer™	List	Each	6 +
Split for Reassembly	1249.30	1039.67	831.74
Load Bearing 4-1/2" Steel Post Inbedded	call for pricing		
Fire Rated in the Material	call for pricing		

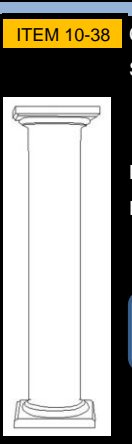

**ITEM 10-38**  
 CAPITAL Square 20-3/4" x 20-3/4" x 7-1/4" (52.7 x 52.7 x 18.4cm)  
 SHAFT Top O/D 16" (40.6cm) Shaft split for post wrap  
 Inside Diameter 12-1/16" (30.64cm)  
 Bottom 16" (44.64 cm)  
 BASE Square 20-3/4" x 20-3/4" x 7-1/4" (52.7 x 52.7 x 18.4cm)  
 Decorative only

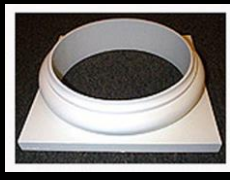

Cap (ArchPolymer)

Base (ArchPolymer)

[click for](#)

[Custom NonTaper PDF Form Composite](#)

IPPC1018S-TBTC	10 Feet 17-1/4" Tapered		
FRP-PolyComp™	List	Each	6 +
Whole	4364.70	3273.53	2618.82
Split in Half (Pilaster)	4516.23	3387.17	2709.74
Whole White Painted	5262.63	3946.97	3157.58
Split in Half White Painted	5414.18	4060.64	3248.51

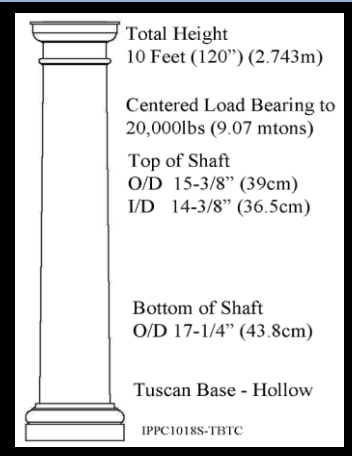
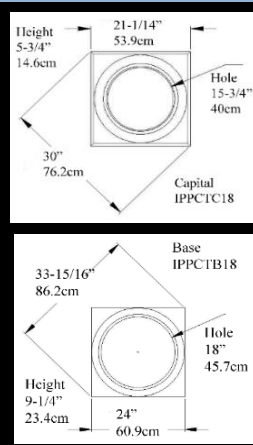

[click for Drawing / Order Form](#)



IPTUS1018S-TCTB 10 Feet 17-1/2" Tapered			
FIBERGLASS	List	Each	6 +
Whole	4471.02	3353.26	2682.61
Split for Post Wrap	4607.25	3455.43	2764.35
Split in Half (Pilaster)	4607.25	3455.43	2764.35
Cut to Height	52.94	39.70	31.76
Split Kit	130.05	97.54	78.03

ITEM 10-40

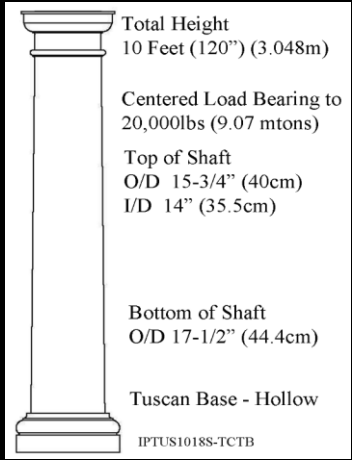
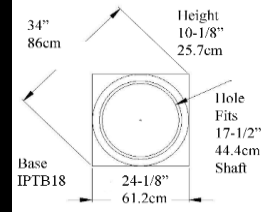
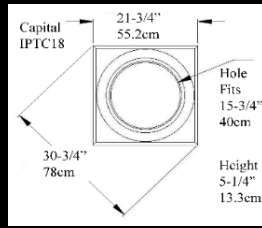

Custom Tapered PDF Form Composite

click for Drawing / Order Form

IPTUS1018SNT-TCTB 10 Feet 17-1/2" Non-Tapered			
FIBERGLASS	List	Each	6 +
Whole	4288.20	3216.15	2572.92
Split for Post Wrap	4424.43	3318.32	2654.66
Split in Half (Pilaster)	4424.43	3318.32	2654.66
Cut to Height	52.94	39.70	31.76
Split Kit	130.05	97.54	78.03

ITEM 10-41

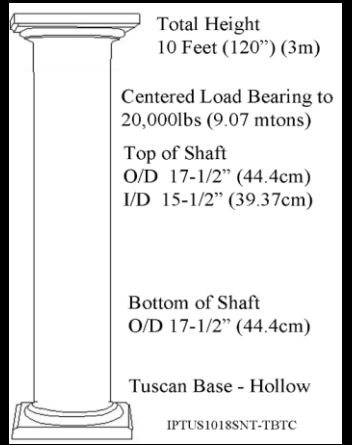
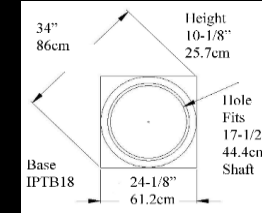
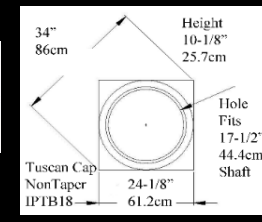

Custom NonTaper PDF Form Composite

click for Drawing / Order Form

IPPC1020SNT-TBTC 10 Feet 19-7/8" Non-Tapered			
FRP-PolyComp™	List	Each	6 +
Whole	5198.05	3898.54	3118.83
Split in Half (Pilaster)	5375.83	4031.87	3225.50
Whole White Painted	6314.51	4735.88	3788.70
Split in Half White Painted	4921.66	3691.24	2953.00

ITEM 10-42

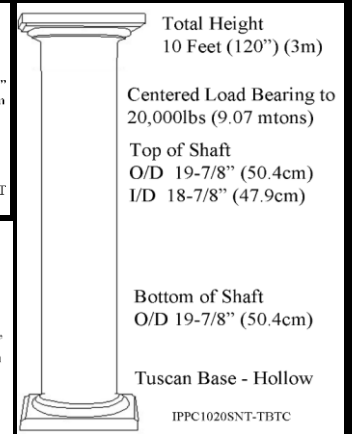
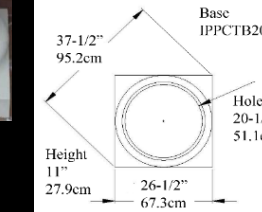
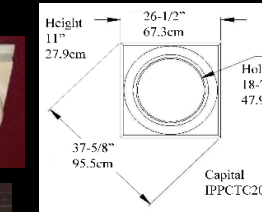

click for Drawing / Order Form

IPT1020-TCTB 10 Feet 20" Tapered			
StoneMold™	Zeament™		

ITEM 10-43



CAPITAL Square 25" x 25" x 11-3/8" (63.5 x 63.5 x 28.89cm)  
 Round call  
 SHAFT Top of Shaft O/D 17" (43.18cm) Inside call  
 Taper ends 2/3rds down Shaft  
 Bottom Shaft O/D 20" (50.8cm)  
 BASE Square call

click for Drawing / Order Form

Decorative only - Seam Remains as a Reveal for post wrap



IPPC1024SNT-TBTC	10 Feet 23-7/8" Non-Tapered		
FRP-PolyComp™	List	Each	6 +
Whole	7457.42	5593.07	4474.45
Split in Half (Pilaster)	7667.72	5750.79	4600.63
Whole White Painted	8878.64	6658.96	5327.17
Split in Half White Painted	5561.27	4170.95	3336.76

ITEM 10-44

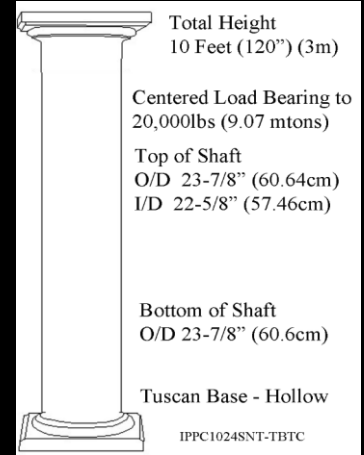
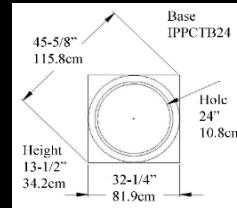
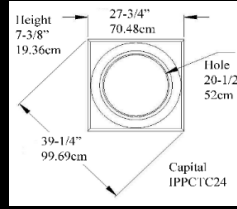

[click for Drawing / Order Form](#)

# 12 Feet (3.66 meter)

Porch Supports & Building Facades

*Best Material: Composites  
or Exterior Hardwoods*



IPAPNT1206P-TCTB	12 Feet 6" NonTapered		
ArchPolymer™	List	Each	6 +
Split for Reassembly	511.07	383.30	306.64

ITEM 12-1

CAPITAL Square 9-1/2" x 9-1/2" x 2-1/2" (24.1 x 24.1 x 6.35cm)  
SHAFT Top & Bottom Shaft O/D 6" (15.2cm)  
Inside Diameter 3-1/2" (8.8cm)  
BASE Square 9-1/2" x 9-1/2" x 4-3/4" (24.1 x 24.1 x 12cm)



[click for Drawing / Order Form](#)

[Custom NonTaper PDF Form Composite](#)

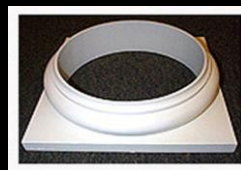

Cap (ArchPolymer)

Base (ArchPolymer)

IPTUS1208SNT-TCTB	12 Feet 7-3/4" Non-Tapered		
FRP-FiberComp™	List	Each	6 +
Whole	662.09	496.56	397.25
Split for Post Wrap	886.55	664.91	531.93
Split in Half (Pilaster)	886.55	664.91	531.93
Cut to Height	52.94	39.70	31.76
Split Kit	430.05	97.54	78.03

ITEM 12-2

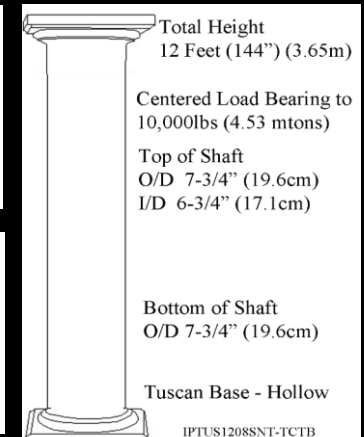
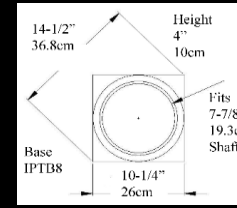
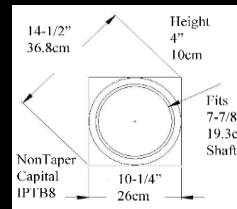

[Custom NonTaper PDF Form Composite](#)

[click for Drawing / Order Form](#)



IPAP1208P-TCTB	12 Feet 8" Tapered		
ArchPolymer™	List	Each	6 +
Split for Reassembly	510.66	501.29	401.03



Cap (ArchPolymer)

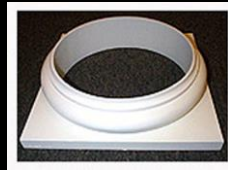

Base (ArchPolymer)

ITEM 12-3



CAPITAL Square 9-1/2" x 9-1/2" x 2-1/2" (24 x 24 x 6.3cm)

SHAFT Top O/D 6" (15.24cm)

Top Inside Diameter 3" (7.62cm)

SHAFT Bottom 8" (20.32cm)

BASE Square 11-1/2" x 11-1/2" x 5-1/4" (29.2 x 29.2 x 13.3cm)

[click for Drawing / Order Form](#)

[Custom Tapered PDF Form Composite](#)

IPC1208P-TCTB	12 Feet 8" Tapered		
Interior Hardwood	List	Each	6 +
Poplar (Paint Grade)	923.40	692.55	554.04
Maple, Bass, Ash, Yellow Birch	1338.93	1004.20	803.36
Sap Maple	1523.61	1142.71	914.17
Beech	1523.61	1142.71	914.17
Alder	1680.59	1260.44	1008.35
Red Oak, African Mahogany	1523.61	1142.71	914.17
Cherry	1662.12	1246.59	997.27
Exterior Hardwood			
White Oak, White Pine, Cedar	1892.97	1419.73	1135.78
Knotty Pine	1154.25	865.69	692.55
Clear Pine	1523.61	1142.71	914.17

ITEM 12-4

[click for Drawing/Order Form](#)

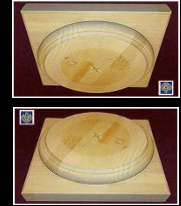

Capital IPWTC08  
Base IPWTB08  
Round  
10" x 1-3/4"  
25.4 x 4.4cm  
Square  
11" x 1-3/4"  
27.9 x 4.4cm

[Custom HW Taper Form](#)



Total Height 12 Feet (144") (3.657m)  
Smooth Tapered Decorative  
Top of Shaft O/D 7" (17.8cm)  
I/D 4" (10cm)  
Bottom of Shaft O/D 8" (20.3cm)  
Options:  
Solid Core for Load  
Split in Half / Wedged  
Inside or Outside Corners

IPCNT1208P-TCTB	12 Feet 8" Non-Tapered		
Interior Hardwood	List	Each	6 +
Poplar (Paint Grade)	1231.20	923.40	738.72
Maple, Bass, Ash, Yellow Birch	1785.24	1338.93	1071.14
Sap Maple	2031.48	1523.61	1218.89
Beech	2031.48	1523.61	1218.89
Alder	2240.78	1680.59	1344.47
Red Oak, African Mahogany	2031.48	1523.61	1218.89
Cherry	2216.16	1662.12	1329.70
Exterior Hardwood			
White Oak, White Pine, Cedar	2523.96	1892.97	1514.38
Knotty Pine	1539.00	1154.25	923.40
Clear Pine	2031.48	1523.61	1218.89

ITEM 12-5

[click for Drawing / Order Form](#)



Capital IPWTC08  
Base IPWTB08  
Round  
10" x 1-3/4"  
25.4 x 4.4cm  
Square  
11" x 1-3/4"  
27.9 x 4.4cm

[Custom HW NonTaper Form](#)



Total Height 12 Feet (144") (3.657m)  
Smooth Non-Tapered Decorative  
Top of Shaft O/D 8" (20.3cm)  
I/D 5" (12.7cm)  
Bottom of Shaft O/D 8" (20.3cm)  
Options:  
Solid Core for Load  
Split in Half / Wedged  
Inside or Outside Corners

IPAPNT1208P-TCTB	12 Feet 8" NonTapered		
ArchPolymer™	List	Each	6 +
Split for Reassembly	645.85	484.39	387.51



Cap (ArchPolymer)

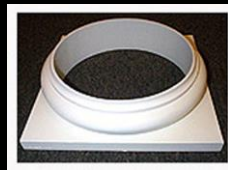

Base (ArchPolymer)

ITEM 12-6

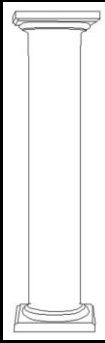

CAPITAL Square 11" x 11" x 3-1/4" (27.9 x 27.9 x 8.2cm)

SHAFT Top & Bottom of Shaft O/D 8" (20.3cm)

Inside Diameter 5-1/2" (13.9cm)

BASE Square 11" x 11" x 3-1/4" (27.9 x 27.9 x 8.2cm)

[click for Drawing / Order Form](#)

[Custom NonTaper PDF Form Composite](#)



IPTUS1210S-TCTB 12 Feet 9-5/8" Tapered			
FRP-FiberComp™	List	Each	6 +
Whole	840.31	630.23	504.19
Split for Post Wrap	1064.77	798.58	638.86
Split in Half (Pilaster)	1064.77	798.58	638.86
Cut to Height	52.94	39.70	31.76
Split Kit	130.05	97.54	78.03

ITEM 12-7

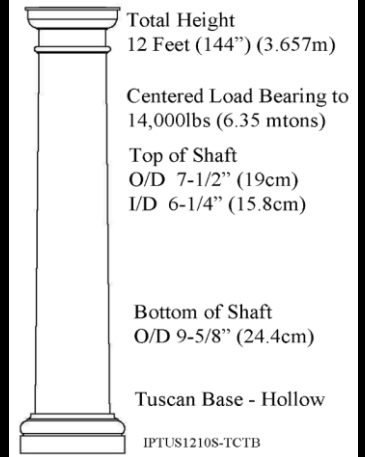
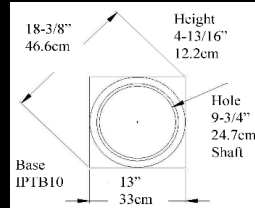
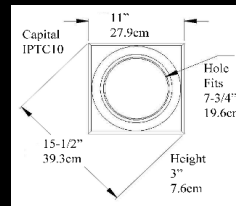

Custom Tapered PDF Form Composite

click for Drawing / Order Form

IPPC1210S-TBTC 12 Feet 9-5/8" Tapered			
FRP-PolyComp™	List	Each	6 +
Whole	809.52	607.14	485.71
Split in Half (Pilaster)	944.17	708.13	566.50
Whole White Painted	1391.19	1043.39	834.71
Split in Half White Painted	1525.90	1144.42	915.54

ITEM 12-8

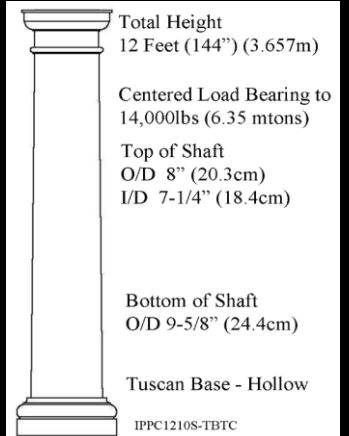
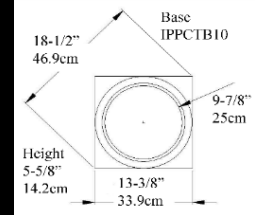
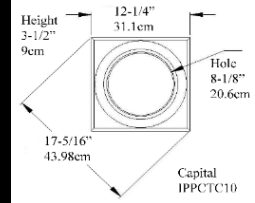

click for Drawing / Order Form

IPPC1210SNT-TBTC 12 Feet 9-5/8" Non-Tapered			
FRP-PolyComp™	List	Each	6 +
Whole	809.52	607.14	485.71
Split in Half (Pilaster)	944.20	708.15	566.52
Whole White Painted	1421.68	1066.26	853.01
Split in Half White Painted	1320.43	990.33	792.26

ITEM 12-9

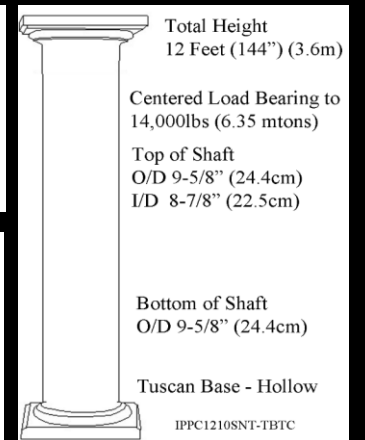
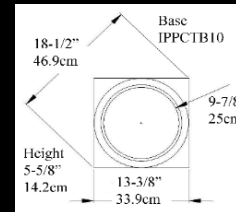
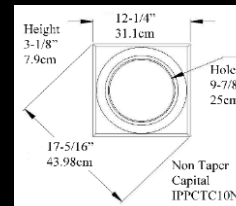

click for Drawing / Order Form

IPTUS1210SNT-TCTB 12 Feet 9-3/4" Non-Tapered			
FRP-FiberComp™	List	Each	6 +
Whole	883.41	662.56	530.05
Split for Post Wrap	1112.97	834.73	667.78
Split in Half (Pilaster)	1112.97	834.73	667.78
Cut to Height	54.14	40.61	32.49
Split Kit	44.94	33.70	26.96

ITEM 12-10

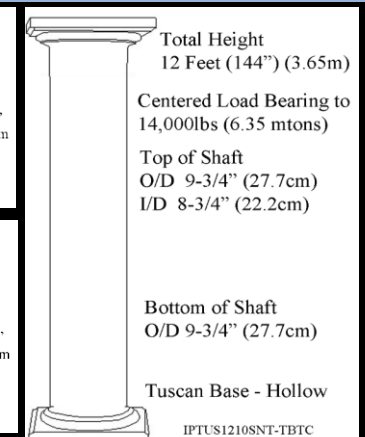
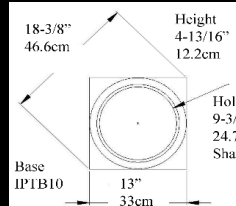
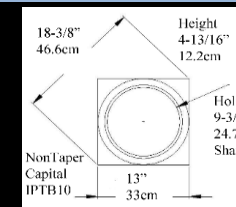

Custom NonTaper PDF Form Composite

click for Drawing / Order Form



IPAP1210P-TCTB	12 Feet 10" Tapered		
ArchPolymer™	List	Each	6 +
Split for Reassembly	840.09	630.07	504.06



Cap (ArchPolymer)



Base (ArchPolymer)

**ITEM 12-11** CAPITAL Square 11-1/2" x 11-1/2" x 2-3/4" (29.2 x 29.2 x 6.9cm)  
 SHAFT Top O/D 8" (20.3cm) Shaft split for post wrap  
 Inside Diameter 5" (12.7 cm)  
 Bottom 10" (25.4cm)  
 BASE Square 13-3/4" x 13-3/4" x 5-3/4" (34.9 x 34.9 x 14.6cm)  
 Decorative only



[click for Drawing /Order Form](#)

[Custom Tapered PDF Form Composite](#)

IPAPNT1210P-TCTB	12 Feet 10" NonTapered		
ArchPolymer™	List	Each	6 +
Split for Reassembly	752.29	609.32	487.46



Cap (ArchPolymer)

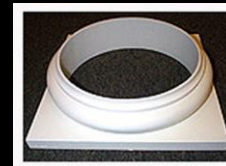

Base (ArchPolymer)

**ITEM 12-12** CAPITAL Square 13-3/4" x 13-3/4" x 5-3/4" (34.9 x 34.9 x 14.6cm)  
 SHAFT Top of Shaft O/D 10" (25.4cm)  
 Inside Diameter 7-1/2" (19cm)  
 SHAFT Bottom O/D 10" (25.4cm)  
 BASE Square 13-3/4" x 13-3/4" x 5-3/4" (33 x 33 x 14.6cm)

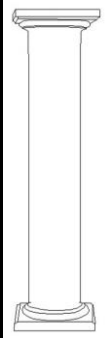

[click for Drawing / Order Form](#)

[Custom NonTaper PDF Form Composite](#)

IPC1210P-TCTB	12 Feet 10" Tapered		
Interior Hardwood	List	Each	6 +
Poplar (Paint Grade)	1203.84	902.88	722.30
Maple, Bass, Ash, Yellow Birch	1745.57	1309.18	1047.34
Sap Maple	1986.34	1489.75	1191.80
Beech	1986.34	1489.75	1191.80
Alder	2190.99	1643.24	1314.59
Red Oak, African Mahogany	1986.34	1489.75	1191.80
Cherry	2166.91	1625.18	1300.15
Exterior Hardwood			
White Oak, White Pine, Cedar	2467.87	1850.90	1480.72
Knotty Pine	1504.80	1128.60	902.88
Clear Pine	1986.34	1489.75	1191.80

**ITEM 12-13** [click for Drawing/Order Form](#)



Capital IPWTC10  
 Base IPWTB10  
 Round 12" x 1-3/4" 30.48 x 4.4cm  
 Square 13" x 1-3/4" 33 x 4.4cm



[Custom HW Taper Form](#)



Total Height 12 Feet (144") (3.657m)  
 Smooth Tapered Decorative  
 Top of Shaft O/D 9" (22.8cm)  
 I/D 6" (15.24cm)  
 Bottom of Shaft O/D 10" (25.4cm)  
 Options: Solid Core for Load  
 Split in Half / Wedged  
 Inside or Outside Corners  
 IPC1210P-TCTB

IPCNT1210P-TCTB	12 Feet 10" Non-Tapered		
Interior Hardwood	List	Each	6 +
Poplar (Paint Grade)	1818.30	1363.73	1090.98
Maple, Bass, Ash, Yellow Birch	2636.54	1977.40	1581.92
Sap Maple	3000.20	2250.15	1800.12
Beech	3000.20	2250.15	1800.12
Alder	3309.31	2481.98	1985.58
Red Oak, African Mahogany	3000.20	2250.15	1800.12
Cherry	3272.94	2454.71	1963.76
Exterior Hardwood			
White Oak, White Pine, Cedar	3727.52	2795.64	2236.51
Knotty Pine	2272.88	1704.66	1363.73
Clear Pine	3000.20	2250.15	1800.12

**ITEM 12-14** [click for Drawing / Order Form](#)



Capital IPWTC10  
 Base IPWTB10  
 Round 12" x 1-3/4" 30.48 x 4.4cm  
 Square 13" x 1-3/4" 33 x 4.4cm



[Custom HW NonTaper Form](#)



Total Height 12 Feet (144") (3.657m)  
 Smooth Non-Tapered Decorative  
 Top of Shaft O/D 10" (25.4cm)  
 I/D 7" (17.78cm)  
 Bottom of Shaft O/D 10" (25.4cm)  
 Options: Solid Core for Load  
 Split in Half / Wedged  
 Inside or Outside Corners  
 IPCNT1210P-TCTB



**IPT1210-TCTB**

**12 Feet 10" Tapered**

ITEM 12-15

CAPITAL Square 12-1/2" x 12-1/2" (63.5 x 63.5cm)

SHAFT Top of Shaft O/D 8-1/2" (21.6cm)

Taper ends 2/3rds to the Bottom of Shaft

Bottom Shaft O/D 10" (25.4cm)

BASE Square 13-3/8" x 13-3/8" x 5-1/4" (33.9 x 33.9 x 13.3cm)

StoneMold™

Zeament™

call



[click for Drawing / Order Form](#)

Decorative only - Seam Remains as a Reveal for post wrap

**IPPC1212S-TBTC**

**12 Feet 11-1/2" Tapered**

ITEM 12-16

FRP-PolyComp™

	List	Each	6 +
Whole	1066.12	799.59	639.67
Split in Half (Pilaster)	1207.03	905.28	724.22
Whole White Painted	1782.78	1337.09	1069.67
Split in Half White Painted	1923.69	1442.77	1154.22

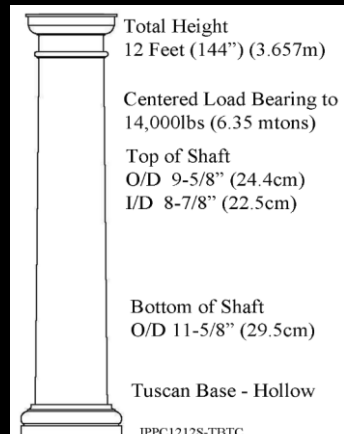
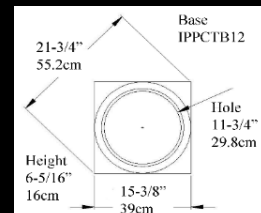
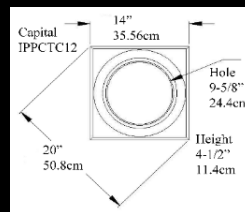

[click for Drawing / Order Form](#)

**IPTUS1212S-TCTB**

**12 Feet 11-5/8" Tapered**

ITEM 12-17

FRP-FiberComp™

	List	Each	6 +
Whole	1136.94	852.71	682.17
Split for Post Wrap	1361.40	1021.05	816.84
Split in Half (Pilaster)	1361.40	1021.05	816.84
Cut to Height	52.94	39.70	31.76
Split Kit	130.05	97.54	78.03

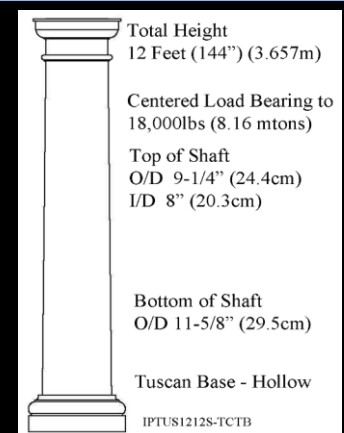
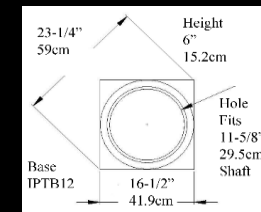
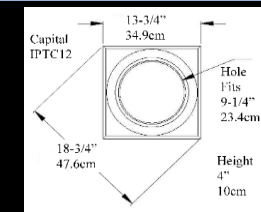

[Custom Tapered PDF Form Composite](#)

[click for Drawing / Order Form](#)

**IPTUS1212SNT-TCTB**

**12 Feet 11-3/4" Non-Tapered**

ITEM 12-18

FRP-FiberComp™

	List	Each	6 +
Whole	1407.99	1055.99	844.79
Split for Post Wrap	1632.45	1224.34	979.47
Split in Half (Pilaster)	1632.45	1224.34	979.47
Cut to Height	52.94	39.70	31.76
Split Kit	130.05	97.54	78.03

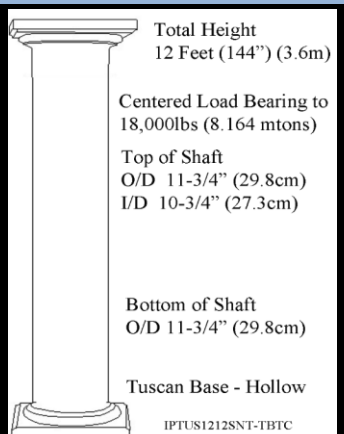
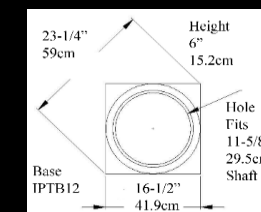
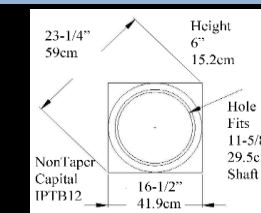

[Custom NonTaper PDF Form Composite](#)

[click for Drawing / Order Form](#)





IPPC1212SNT-TBTC	12 Feet 11-3/4" Non-Tapered		
FRP-PolyComp™	List	Each	6 +
Whole	1066.18	799.63	639.71
Split in Half (Pilaster)	1207.03	905.28	724.22
Whole White Painted	1809.89	1357.42	1085.94
Split in Half White Painted	1622.36	1216.77	973.42

ITEM 12-19

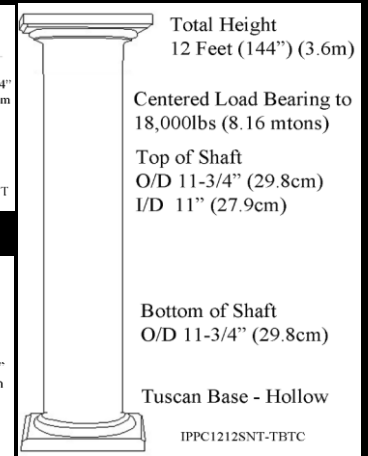
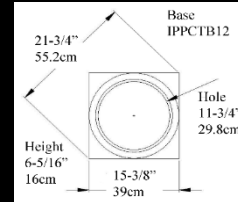
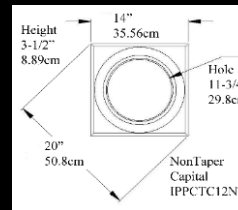

[click for Drawing / Order Form](#)

IPAP1212P-TCTB	12 Feet 12" Tapered		
ArchPolymer™	List	Each	6 +
Split for Reassembly	800.30	640.24	618.90

ITEM 12-20



Cap (ArchPolymer)

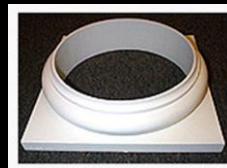

Base (ArchPolymer)



CAPITAL Square 13-3/4" x 13-3/4" x 5-3/4" (34.9 x 34.9 x 26cm)  
 SHAFT Top O/D 10" (25.4cm) Shaft split for post wrap  
 Inside Diameter 7" (17.78 cm)  
 Bottom 12" (30.48cm)  
 BASE Square 15-3/4" x 15-3/4" x 6-1/4" (40 x 40 x 15.8cm)  
 Decorative only

[click for Drawing / Order Form](#)

IPAPNT1212P-TCTB	12 Feet 12" NonTapered		
ArchPolymer™	List	Each	6 +
Split for Reassembly	1029.02	771.76	617.41

ITEM 12-21



Cap (ArchPolymer)

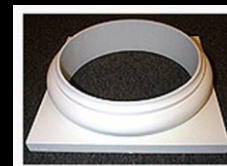

Base (ArchPolymer)

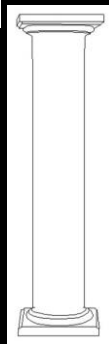

CAPITAL Square 15-3/4" x 15-3/4" x 3-1/2" (40 x 40 x 8.9cm)  
 SHAFT Top & Bottom O/D 12" (30.48cm)  
 Inside Diameter 9-1/2" (24cm)  
 Decorative - not load bearing  
 BASE Square 15-3/4" x 15-3/4" x 6-1/4" (40 x 40 x 15.8cm)

[click for Drawing / Order Form](#)

[Custom NonTaper PDF Form Composite](#)

IPC1212P-TCTB	12 Feet 12" Tapered		
Interior Hardwood	List	Each	6 +
Poplar (Paint Grade)	1818.30	1363.73	1090.98
Maple, Bass, Ash, Yellow Birch	2636.54	1977.40	1581.92
Sap Maple	3000.20	2250.15	1800.12
Beech	3000.20	2250.15	1800.12
Alder	3309.31	2481.98	1985.58
Red Oak, African Mahogany	3000.20	2250.15	1800.12
Cherry	3272.94	2454.71	1963.76
Exterior Hardwood			
White Oak, White Pine, Cedar	3727.52	2795.64	2236.51
Knotty Pine	2272.88	1704.66	1363.73
Clear Pine	3000.20	2250.15	1800.12

ITEM 12-22

[click for Drawing/Order Form](#)

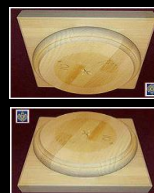

Capital IPWTC12  
 Base IPWTB12  
 Round 14" x 1-3/4"  
 35.5 x 4.4cm  
 Square 15" x 1-3/4"  
 38 x 4.4cm

[Custom HW Taper Form](#)



Total Height 12 Feet (144") (3.657m)  
 Smooth Tapered Decorative  
 Top of Shaft O/D 11" (27.9cm)  
 I/D 8" (20.3cm)  
 Bottom of Shaft O/D 12" (30.48cm)  
 Options: Solid Core for Load Split in Half/ Wedged Inside or Outside Corners  
 IPC1212P-TCTB



IPCNT1212P-TCTB 12 Feet 12" Non-Tapered			
Interior Hardwood	List	Each	6 +
Poplar (Paint Grade)	2307.36	1730.52	1384.42
Maple, Bass, Ash, Yellow Birch	3345.67	2509.25	2007.40
Sap Maple	3807.14	2855.36	2284.29
Beech	3807.14	2855.36	2284.29
Alder	4199.40	3149.55	2519.64
Red Oak, African Mahogany	3807.14	2855.36	2284.29
Cherry	4153.25	3114.94	2491.95
Exterior Hardwood			
White Oak, White Pine, Cedar	4730.09	3547.57	2838.05
Knotty Pine	2884.20	2163.15	1730.52
Clear Pine	3807.14	2855.36	2284.29

ITEM 12-23

[click for Drawing / Order Form](#)



Capital IPWTC12  
Base IPWTB12  
Round  
14" x 1-3/4"  
35.5 x 4.4cm  
Square  
15" x 1-3/4"  
38 x 4.4cm

Custom HW NonTaper Form



Total Height  
12 Feet (144") (3.048m)  
Smooth Non-Tapered  
Decorative  
Top of Shaft  
O/D 12" (30.48cm)  
I/D 11" (27.9cm)  
Bottom of Shaft  
O/D 12" (30.48cm)  
Options:  
Solid Core for Load  
Split in Half / Wedged  
Inside or Outside Corners

IPCNT1212P-TCTB

IPT1212-TCTB 12 Feet 12" Tapered			
StoneMold™	Zeament™	call	

ITEM 12-24

CAPITAL Square 15-1/2" x 15-1/2" (39.4 x 39.4cm)

Round call

SHAFT Top of Shaft O/D 10" (25.4cm) Inside call

Taper ends 2/3rds down Shaft

Bottom Shaft O/D 12" (30.5cm)

BASE Square 16-3/4" x 16-3/4" (42.5 x 42.5cm)

[click for Drawing / Order Form](#)

Decorative only - Seam Remains as a Reveal for post wrap

IPTUS1214S-TCTB 12 Feet 13-5/8" Tapered			
FRP-FiberComp™	List	Each	6 +
Whole	1952.73	1464.55	1171.64
Split for Post Wrap	2177.19	1632.89	1306.31
Split in Half (Pilaster)	2177.19	1632.89	1306.31
Cut to Height	52.94	39.70	31.76
Split Kit	130.05	97.54	78.03

ITEM 12-25

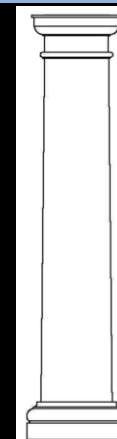
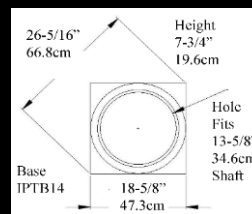
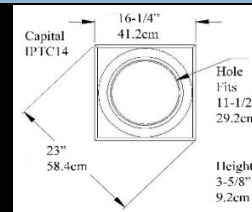

Total Height  
12 Feet (144") (3.657m)  
Centered Load Bearing to  
20,000lbs (9.07 mtons)  
Top of Shaft  
O/D 11-1/2" (29.2cm)  
I/D 10-1/2" (26cm)

Bottom of Shaft  
O/D 13-5/8" (34.6cm)

Tuscan Base - Hollow

IPTUS1214S-TCTB



Custom Tapered PDF Form  
Composite

[click for Drawing / Order Form](#)

IPPC1214SNT-TBTC 12 Feet 13-3/4" Non-Tapered			
FRP-PolyComp™	List	Each	6 +
Whole	1927.33	1445.49	1156.40
Split in Half (Pilaster)	2076.96	1557.72	1246.18
Whole White Painted	2765.45	2074.09	1659.27
Split in Half White Painted	2366.99	1775.24	1420.20

ITEM 12-26

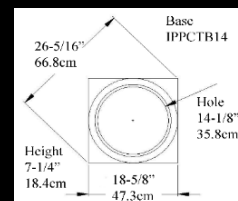
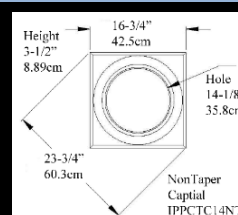
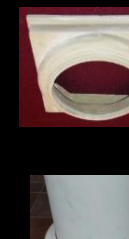

Total Height  
12 Feet (144") (3.6m)  
Centered Load Bearing to  
20,000lbs (9.07 mtons)  
Top of Shaft  
O/D 13-3/4" (34.9cm)  
I/D 13" (33cm)

Bottom of Shaft  
O/D 13-3/4" (34.9cm)

Tuscan Base - Hollow

IPPC1214SNT-TBTC

[click for Drawing / Order Form](#)



IPPC1214S-TBTC	12 Feet 13-7/8" Tapered		
FRP-PolyComp™	List	Each	6 +
Whole	1927.30	1445.47	1156.38
Split in Half (Pilaster)	2076.70	1557.53	1246.02
Whole White Painted	2722.21	2041.65	1633.32
Split in Half White Painted	2871.61	2153.71	1722.97

ITEM 12-27

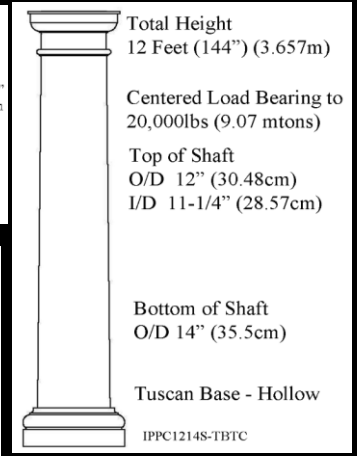
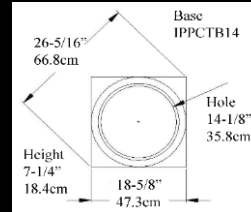
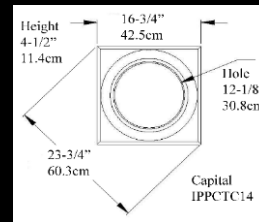

[click for Drawing / Order Form](#)

IPAP1214P-TCTB	12 Feet 14" Tapered		
ArchPolymer™	List	Each	6 +
Split for Reassembly	1280.55	960.41	768.33
Load Bearing 4-1/2" Steel Post Inbedded	call for pricing		
Fire Rated in the Material	call for pricing		

ITEM 12-28



CAPITAL Square 15-3/4" x 15-3/4" x 3-1/2" (40 x 40 x 8.9cm)  
 SHAFT Top O/D 12" (30.48cm) Shaft split for post wrap  
 Inside Diameter 9" (22.86 cm)  
 Bottom 14" (35.56cm)  
 BASE Square 18-3/4" x 18-3/4" x 6-3/4" (47.6 x 47.6 x 17cm)  
 Decorative only

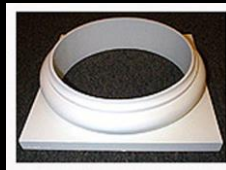

Cap (ArchPolymer)

Base (ArchPolymer)

[click for Drawing / Order Form](#)

IPAPNT1214P-TCTB	12 Feet 14" NonTapered		
ArchPolymer™	List	Each	6 +
Split for Reassembly	1233.72	925.29	740.23
Load Bearing 4-1/2" Steel Post Inbedded	call for pricing		
Fire Rated in the Material	call for pricing		

ITEM 12-29

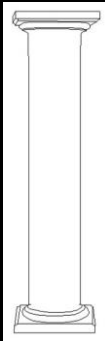

CAPITAL Square 18-3/4" x 18-3/4" x 4" (47.6 x 47.6 x 10cm)  
 SHAFT Top & Bottom O/D 14" (35.8cm)  
 Inside Diameter 10-1/4" (26cm)  
 Decorative - not load bearing  
 BASE Square 18-3/4" x 18-3/4" x 6-3/4" (47.6 x 47.6 x 17cm)

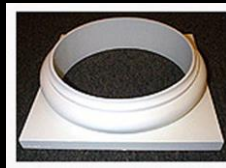

Cap (ArchPolymer)

Base (ArchPolymer)

[click for Drawing / Order Form](#)

[Custom NonTaper PDF Form Composite](#)

IPTUS1216S-TCTB	12 Feet 15-1/2" Tapered		
FRP-FiberComp™	List	Each	6 +
Whole	2605.11	1953.83	1563.07
Split for Post Wrap	2923.45	2192.58	1754.07
Split in Half (Pilaster)	2923.45	2192.58	1754.07
Cut to Height	52.94	39.70	31.76
Split Kit	130.05	97.54	78.03

ITEM 12-30

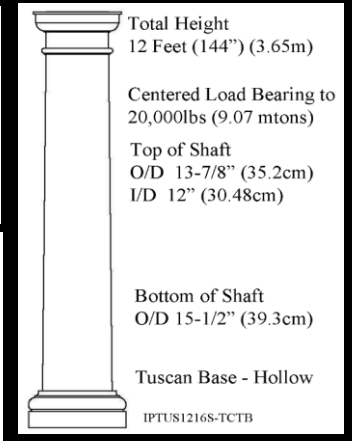
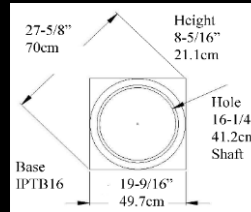
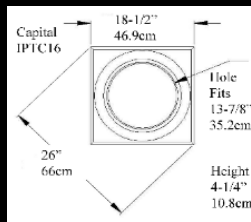

[Custom Tapered PDF Form Composite](#)

[click for Drawing / Order Form](#)



<b>IPATUS1216SNT-TCTB</b>	<b>12 Feet 15-1/2" Non-Tapered</b>			<b>ITEM 12-31</b>
<b>Fiberglass</b>	<b>List</b>	<b>Each</b>	<b>6 +</b>	
Whole	3319.07	2489.31	1991.44	
Split for Post Wrap	3455.30	2591.48	2073.18	
Split in Half (Pilaster)	3455.30	2591.48	2073.18	
Cut to Height	52.94	39.70	31.76	
Split Kit	130.05	97.54	78.03	



Custom NonTaper PDF Form Composite

click for Drawing / Order Form

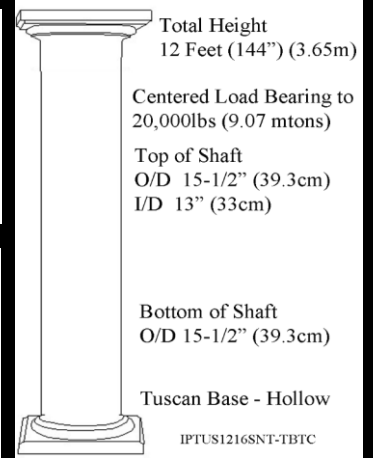
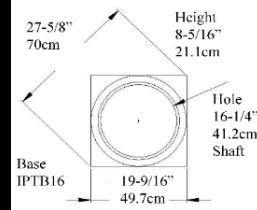
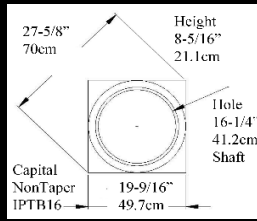

<b>IPPC1216S-TBTC</b>	<b>12 Feet 15-3/4" Tapered</b>			<b>ITEM 12-32</b>
<b>FRP-PolyComp™</b>	<b>List</b>	<b>Each</b>	<b>6 +</b>	
Whole	2611.32	1958.49	1566.79	
Split in Half (Pilaster)	2775.14	2081.36	1665.09	
Whole White Painted	3520.52	2640.39	2112.31	
Split in Half White Painted	3684.37	2763.27	2210.62	

click for Drawing / Order Form

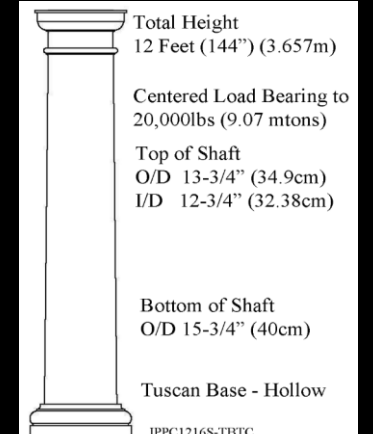
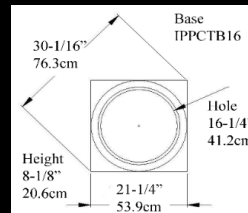
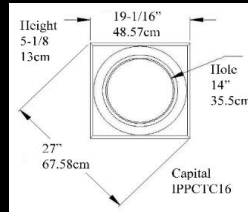

<b>IPAP1216P-TCTB</b>	<b>12 Feet 16" Tapered</b>			<b>ITEM 12-33</b>
<b>ArchPolymer™</b>	<b>List</b>	<b>Each</b>	<b>6 +</b>	
Split for Reassembly	1428.64	1071.48	841.18	
Load Bearing 4-1/2" Steel Post Inbedded	call for pricing			
Fire Rated in the Material	call for pricing			



Cap (ArchPolymer)



Base (ArchPolymer)

**CAPITAL** Square 15-3/4" x 15-3/4" x 3-1/2" (40 x 40 x 8.9cm)  
**SHAFT** Top O/D 12" (30.48cm) Shaft split for post wrap  
 Inside Diameter 9" (22.86 cm)  
 Bottom 14" (35.56cm)  
**BASE** Square 18-3/4" x 18-3/4" x 6-3/4" (47.6 x 47.6 x 17cm)  
 Decorative only

click for Drawing / Order Form

<b>IPAPNT1216P-TCTB</b>	<b>12 Feet 16" NonTapered</b>			<b>ITEM 12-34</b>
<b>ArchPolymer™</b>	<b>List</b>	<b>Each</b>	<b>6 +</b>	
Split for Reassembly	1370.44	1130.53	904.42	
Load Bearing 4-1/2" Steel Post Inbedded	call for pricing			
Fire Rated in the Material	call for pricing			



Cap (ArchPolymer)

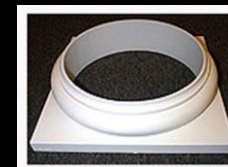

Base (ArchPolymer)

**CAPITAL** Square 20-3/4" x 20-3/4" x 7-1/4" (52.7 x 52.7 x 18.4cm)  
**SHAFT** Top O/D 16" (40.6cm) Shaft split for post wrap  
 Inside Diameter 12-1/16" (30.64cm)  
 Bottom 16" (44.64 cm)  
**BASE** Square 20-3/4" x 20-3/4" x 7-1/4" (52.7 x 52.7 x 18.4cm)  
 Decorative only

click for Drawing / Order Form

Custom NonTaper PDF Form Composite



IPPC1218S-TBTC	12 Feet 17-1/4" Tapered		
FRP-PolyComp™	List	Each	6 +
Whole	4607.72	3455.79	2764.63
Split in Half (Pilaster)	4787.55	3590.67	2872.53
Whole White Painted	5646.56	4234.92	3387.93
Split in Half White Painted	5826.39	4369.79	3495.84

ITEM 12-35

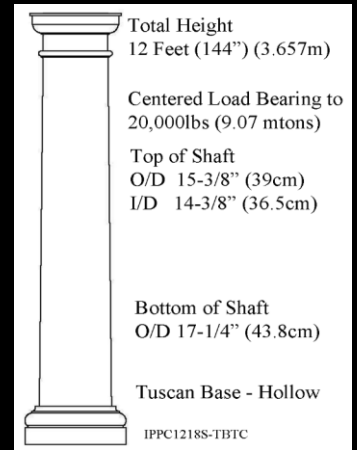
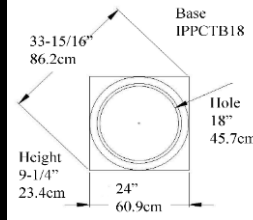
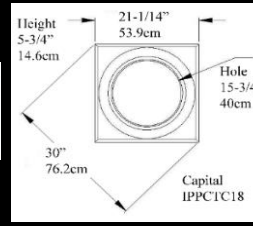

[click for Drawing / Order Form](#)

IPTUS1218S-TCTB	12 Feet 17-1/2" Tapered		
FRP-FiberComp™	List	Each	6 +
Whole	4859.76	3644.82	2915.86
Split for Post Wrap	4995.99	3746.99	2997.60
Split in Half (Pilaster)	4995.99	3746.99	2997.60
Cut to Height	52.94	39.70	31.76
Split Kit	130.05	97.54	78.03

ITEM 12-36

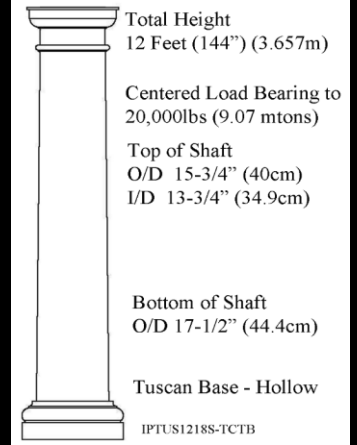
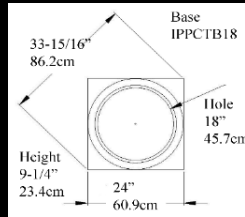
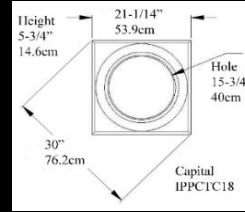

[Custom Tapered PDF Form Composite](#)

[click for Drawing / Order Form](#)

IPTUS1218SNT-TCTB	12 Feet 17-1/2" Non-Tapered		
Fiberglass	List	Each	6 +
Whole	5017.70	3763.27	3010.62
Split for Post Wrap	5153.93	3865.44	3092.36
Split in Half (Pilaster)	5153.93	3865.44	3092.36
Cut to Height	52.94	39.70	31.76
Split Kit	130.05	97.54	78.03

ITEM 12-37

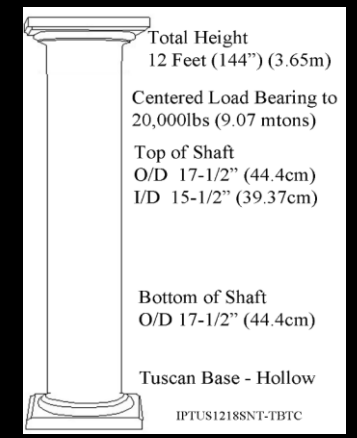
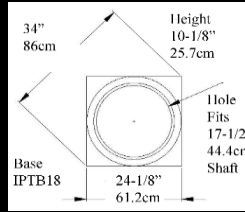
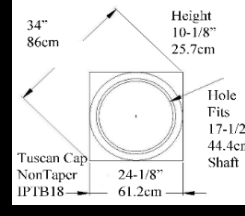

[Custom NonTaper PDF Form Composite](#)

[click for Drawing / Order Form](#)

IPTUS1220S-TCTB	12 Feet 19-1/2" Tapered		
FRP-FiberComp™	List	Each	6 +
Whole	5153.04	3864.78	3091.83
Split for Post Wrap	5365.50	4024.13	3219.30
Split in Half (Pilaster)	5365.50	4024.13	3219.30
Cut to Height	52.94	39.70	31.76
Split Kit	130.05	97.54	78.03

ITEM 12-38

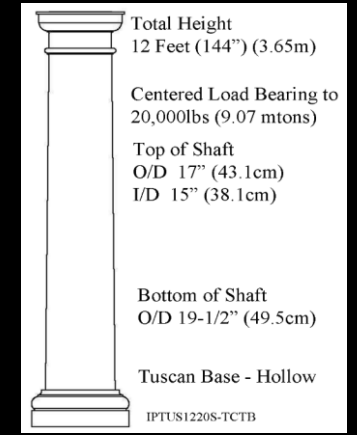
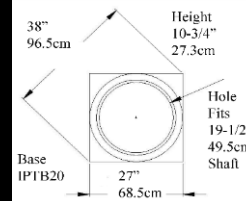
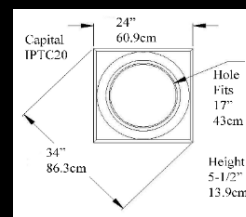

[Custom Tapered PDF Form Composite](#)

[click for Drawing / Order Form](#)



IPPC1220S-TBTC		12 Feet 19-3/4" Tapered		ITEM 12-35
FRP-PolyComp™	List	Each	6 +	
Whole	5728.35	4296.26	3437.01	
Split in Half (Pilaster)	5874.78	4406.09	3524.87	
Whole White Painted	6787.84	5090.88	4072.70	
Split in Half White Painted	6934.27	5200.70	4160.56	

[click for Drawing / Order Form](#)

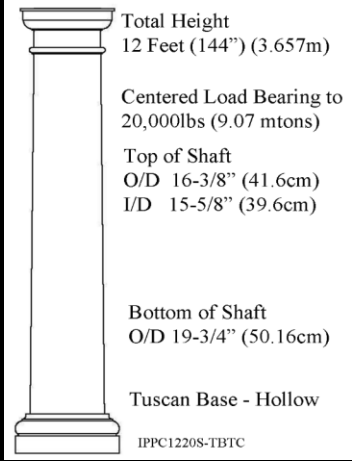
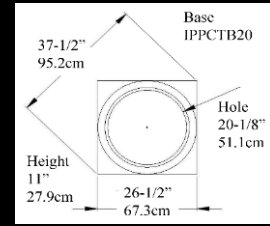
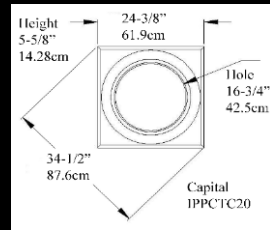

IPTUS1222S-TCTB		12 Feet 21-1/2" Tapered		ITEM 12-39
FRP-FiberComp™	List	Each	6 +	
Whole	6277.28	4707.96	3766.37	
Split for Post Wrap	6489.74	4867.31	3893.85	
Split in Half (Pilaster)	6489.74	4867.31	3893.85	
Cut to Height	52.94	39.70	31.76	
Split Kit	130.05	97.54	78.03	



[Custom Tapered PDF Form Composite](#)

[click for Drawing / Order Form](#)

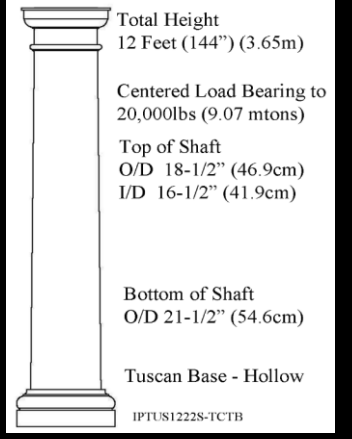
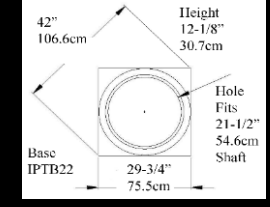
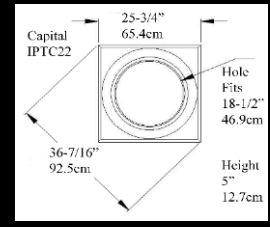

IPTUS1224S-TCTB		12 Feet 23-1/2" Tapered		ITEM 12-40
FRP-FiberComp™	List	Each	6 +	
Whole	6871.43	5153.57	4122.86	
Split for Post Wrap	7083.89	5312.92	4250.33	
Split in Half (Pilaster)	7083.89	5312.92	4250.33	
Cut to Height	52.94	39.70	31.76	
Split Kit	130.05	97.54	78.03	



[Custom Tapered PDF Form Composite](#)

[click for Drawing / Order Form](#)

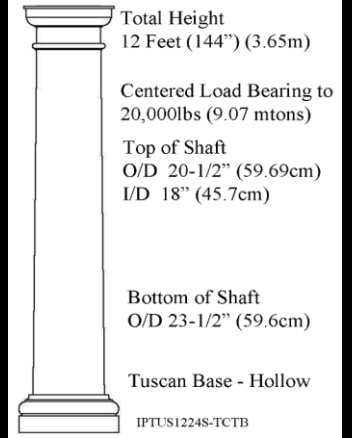
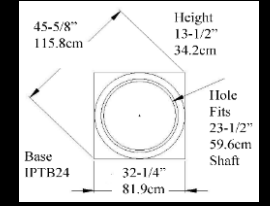
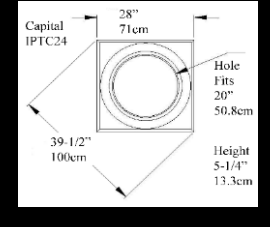

# 14 Feet (4.27 meter)

Porch Supports & Building Facades

*Best Material: Composites  
or Exterior Hardwoods*





IPC1410P-TCTB		14 Feet 10" Tapered		
Interior Hardwood	List	Each	6 +	
Poplar (Paint Grade)	1404.48	1053.36	842.69	
Maple, Bass, Ash, Yellow Birch	2036.50	1527.37	1221.90	
Sap Maple	2317.39	1738.04	1390.44	
Beech	2317.39	1738.04	1390.44	
Alder	2556.15	1917.12	1533.69	
Red Oak, African Mahogany	2317.39	1738.04	1390.44	
Cherry	2528.06	1896.05	1516.84	
Exterior Hardwood				
White Oak, White Pine, Cedar	2879.18	2159.39	1727.51	
Knotty Pine	1755.60	1316.70	1053.36	
Clear Pine	2317.39	1738.04	1390.44	

ITEM 14-1

[click for Drawing/Order Form](#)



Capital IPWTC10  
Base IPWTB10  
Round  
12" x 1-3/4"  
30.48 x 4.4cm  
Square  
13" x 1-3/4"  
33 x 4.4cm



Custom HW Taper Form



Total Height  
14 Feet (4.267m)  
Smooth Tapered  
Decorative  
Top of Shaft  
O/D 9" (22.8cm)  
I/D 6" (15.24cm)  
Bottom of Shaft  
O/D 10" (25.4cm)  
Options:  
Solid Core for Load  
Split in Half / Wedged  
Inside or Outside Corners

IPC1410P-TCTB

IPCNT1410P-TCTB		14 Feet 10" Non-Tapered		
Interior Hardwood	List	Each	6 +	
Poplar (Paint Grade)	2006.40	1504.80	1203.84	
Maple, Bass, Ash, Yellow Birch	2909.28	2181.96	1745.57	
Sap Maple	3310.56	2482.92	1986.34	
Beech	3310.56	2482.92	1986.34	
Alder	3651.65	2738.74	2190.99	
Red Oak, African Mahogany	3310.56	2482.92	1986.34	
Cherry	3611.52	2708.64	2166.91	
Exterior Hardwood				
White Oak, White Pine, Cedar	4113.12	3084.84	2467.87	
Knotty Pine	2508.00	1881.00	1504.80	
Clear Pine	3310.56	2482.92	1986.34	

ITEM 14-2

[click for Drawing / Order Form](#)



Capital IPWTC10  
Base IPWTB10  
Round  
12" x 1-3/4"  
30.48 x 4.4cm  
Square  
13" x 1-3/4"  
33 x 4.4cm



Custom HW NonTaper Form



Total Height  
14 Feet (4.267m)  
Smooth Non-Tapered  
Decorative  
Top of Shaft  
O/D 10" (25.4cm)  
I/D 7" (17.78cm)  
Bottom of Shaft  
O/D 10" (25.4cm)  
Options:  
Solid Core for Load  
Split in Half / Wedged  
Inside or Outside Corners

IPCNT1410P-TCTB

IPPC1412S-TBTC		14 Feet 11-1/2" Tapered		
FRP-PolyComp™	List	Each	6 +	
Whole	1638.61	1228.96	983.17	
Split in Half (Pilaster)	1812.84	1359.63	1087.70	
Whole White Painted	2479.19	1859.39	1487.51	
Split in Half White Painted	2653.45	1990.09	1592.07	

ITEM 14-3

[click for Drawing / Order Form](#)

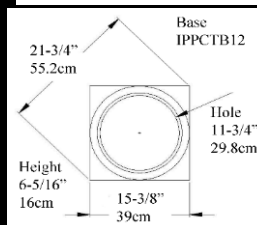
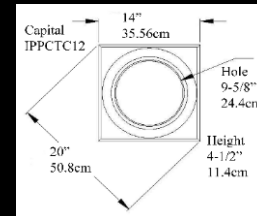

Total Height  
14 Feet (4.267m)  
Centered Load Bearing to  
14,000lbs (6.35 mtons)  
Top of Shaft  
O/D 9-3/8" (23.8cm)  
I/D 8-5/8" (21.9cm)  
Bottom of Shaft  
O/D 11-1/2" (29.2cm)  
Tuscan Base - Hollow

IPPC1412S-TBTC

IPPC1412SNT-TBTC		14 Feet 11-3/4" Non-Tapered		
FRP-PolyComp™	List	Each	6 +	
Whole	1638.67	1229.00	983.20	
Split in Half (Pilaster)	1812.84	1359.63	1087.70	
Whole White Painted	2506.30	1879.73	1503.78	
Split in Half White Painted	2638.12	1978.59	1582.87	

ITEM 14-4

[click for Drawing / Order Form](#)

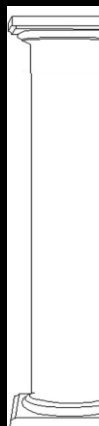
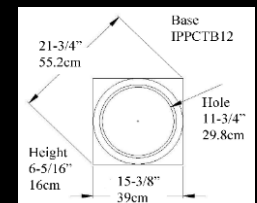
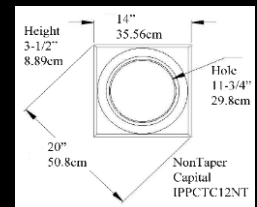

Total Height  
14 Feet (4.267m)  
Centered Load Bearing to  
18,000lbs (8.16 mtons)  
Top of Shaft  
O/D 11-5/8" (29.5cm)  
I/D 10-7/8" (27.6cm)  
Bottom of Shaft  
O/D 11-5/8" (29.5cm)  
Tuscan Base - Hollow

IPPC1412SNT-TBTC



IPTUS1412SNT-TCTB		14 Feet 11-3/4" Non-Tapered		
FRP-FiberComp™	List	Each	6 +	
Whole	1612.69	1209.51	967.61	
Split for Post Wrap	1837.15	1377.86	1102.29	
Split in Half (Pilaster)	1837.15	1377.86	1102.29	
Cut to Height	52.94	39.70	31.76	
Split Kit	130.05	97.54	78.03	

ITEM 14-5

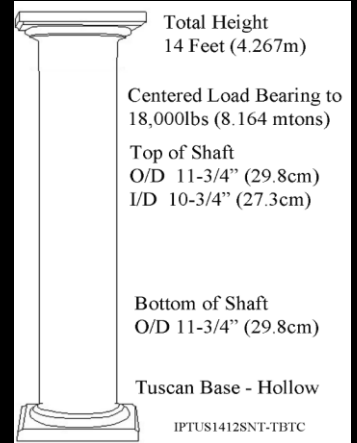
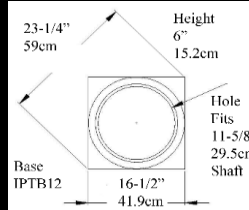
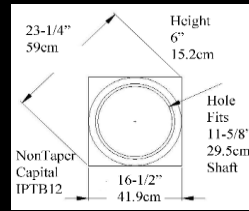

Custom NonTaper PDF Form Composite

click for Drawing / Order Form

IPC1412P-TCTB		14 Feet 12" Tapered		
Interior Hardwood	List	Each	6 +	
Poplar (Paint Grade)	2006.40	1504.80	1203.84	
Maple, Bass, Ash, Yellow Birch	2909.28	2181.96	1745.57	
Sap Maple	3310.56	2482.92	1986.34	
Beech	3310.56	2482.92	1986.34	
Alder	3651.65	2738.74	2190.99	
Red Oak, African Mahogany	3310.56	2482.92	1986.34	
Cherry	3611.52	2708.64	2166.91	
Exterior Hardwood	List	Each	6 +	
White Oak, White Pine, Cedar	4113.12	3084.84	2467.87	
Knotty Pine	2508.00	1881.00	1504.80	
Clear Pine	3310.56	2482.92	1986.34	

ITEM 14-6



click for Drawing/Order Form

Capital IPWTC12  
Base IPWTB12  
Round  
14" x 1-3/4"  
35.5 x 4.4cm  
Square  
15" x 1-3/4"  
38 x 4.4cm

Custom HW Taper Form

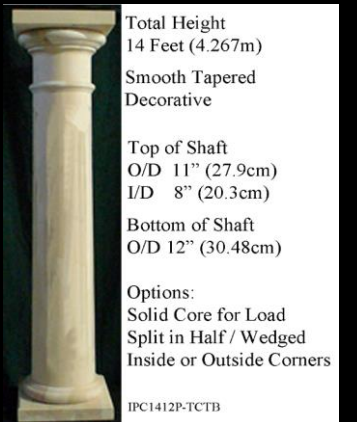

IPTUS1414S-TCTB		14 Feet 13-5/8" Tapered		
FRP-FiberComp™	List	Each	6 +	
Whole	2721.57	2041.18	1632.94	
Split for Post Wrap	2763.92	2072.94	1658.35	
Split in Half (Pilaster)	2763.92	2072.94	1658.35	
Cut to Height	52.94	39.70	31.76	
Split Kit	130.05	97.54	78.03	

ITEM 14-7

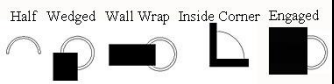
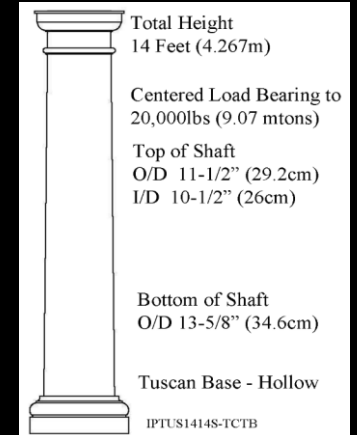
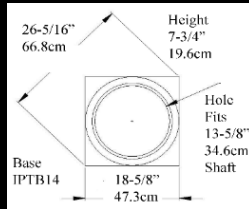
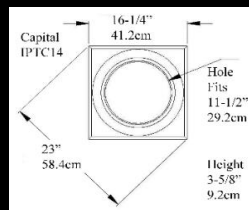

Custom Tapered PDF Form Composite

click for Drawing / Order Form

IPPC1414SNT-TBTC		14 Feet 13-3/4" Non-Tapered		
FRP-PolyComp™	List	Each	6 +	
Whole	2348.29	1761.22	1408.97	
Split in Half (Pilaster)	2620.05	1965.03	1572.03	
Whole White Painted	3296.21	2472.16	1977.72	
Split in Half White Painted	3019.82	2264.86	1811.89	

ITEM 14-8

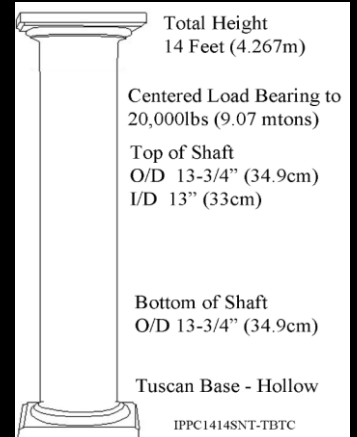
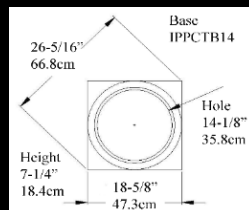
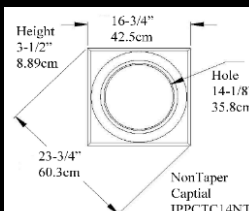

click for Drawing / Order Form





IPPC1414S-TBTC	14 Feet 13-1/8" Tapered		
<b>FRP-PolyComp™</b>	List	Each	6 +
Whole	2436.29	1827.22	1461.77
Split in Half (Pilaster)	2621.76	1966.32	1573.06
Whole White Painted	3340.97	2505.72	2004.58
Split in Half White Painted	3524.72	2643.54	2114.83

ITEM 14-9

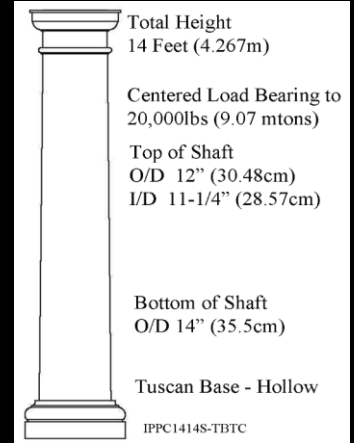
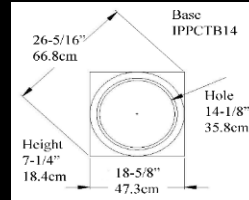
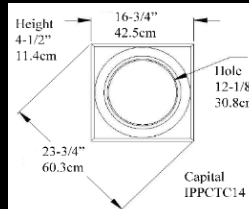

[click for Drawing / Order Form](#)

IPTUS1416S-TCTB	14 Feet 15-1/2" Tapered		
<b>FRP-FiberComp™</b>	List	Each	6 +
Whole	3233.84	2425.38	1940.31
Split for Post Wrap	3233.84	2425.38	1940.31
Split in Half (Pilaster)	3233.84	2425.38	1940.31
Cut to Height	52.94	39.70	31.76
Split Kit	130.05	97.54	78.03

ITEM 14-10

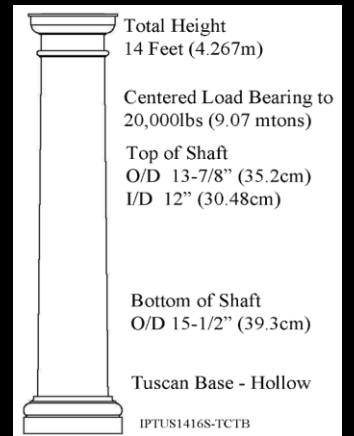
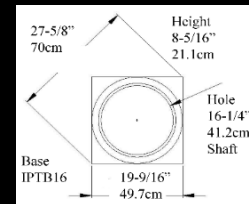
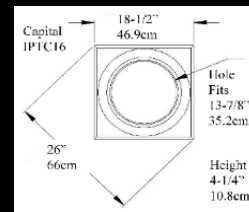

Custom Tapered PDF Form Composite

[click for Drawing / Order Form](#)

IPPC1416S-TBTC	14 Feet 15-3/4" Tapered		
<b>FRP-PolyComp™</b>	List	Each	6 +
Whole	3297.09	2472.82	1978.26
Split in Half (Pilaster)	3915.65	2936.74	2349.39
Whole White Painted	4331.61	3248.71	2598.97
Split in Half White Painted	4950.20	3712.65	2970.12

ITEM 14-11

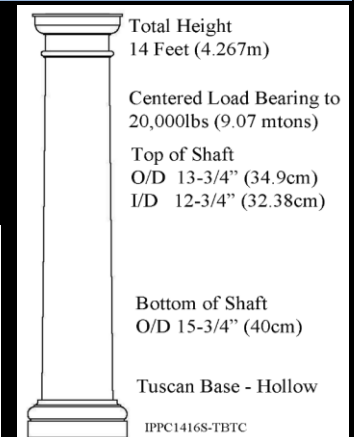
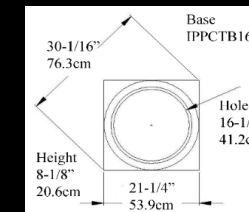
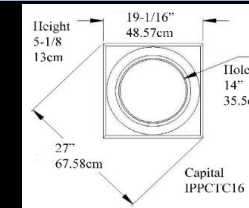

[click for Drawing / Order Form](#)

IPPC1418S-TBTC	14 Feet 17-1/4" Tapered		
<b>FRP-PolyComp™</b>	List	Each	6 +
Whole	4764.25	3573.18	2858.55
Split in Half (Pilaster)	4976.34	3732.26	2985.81
Whole White Painted	6086.48	4564.86	3651.89
Split in Half White Painted	6156.06	4617.05	3693.64

ITEM 14-12

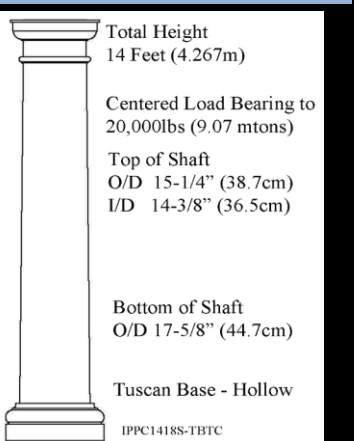
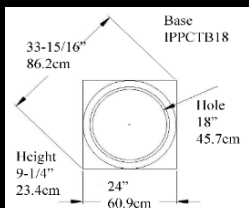
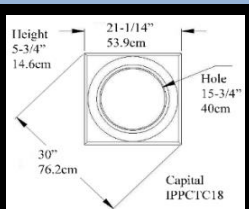
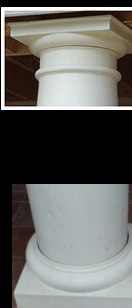

[click for Drawing / Order Form](#)



IPTUS1418S-TCTB 14 Feet 17-1/2" Tapered			
FRP-FiberComp™	List	Each	6 +
Whole	5102.75	3827.06	3061.65
Split for Post Wrap	5238.98	3929.24	3143.39
Split in Half (Pilaster)	5238.98	3929.24	3143.39
Cut to Height	52.94	39.70	31.76
Split Kit	130.05	97.54	78.03

ITEM 14-13

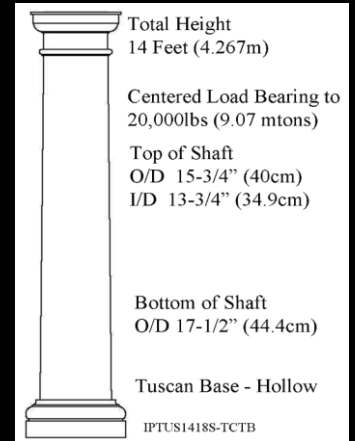
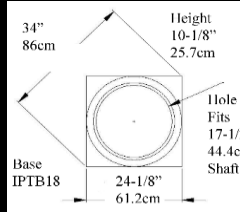
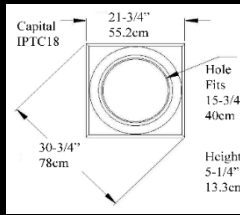

Custom Tapered PDF Form Composite

[click for Drawing / Order Form](#)

IPTUS1420S-TCTB 14 Feet 19-1/2" Tapered			
FRP-FiberComp™	List	Each	6 +
Whole	5782.13	4336.60	3469.28
Split for Post Wrap	5994.59	4495.94	3596.75
Split in Half (Pilaster)	5994.59	4495.94	3596.75
Cut to Height	52.94	39.70	31.76
Split Kit	130.05	97.54	78.03

ITEM 14-14

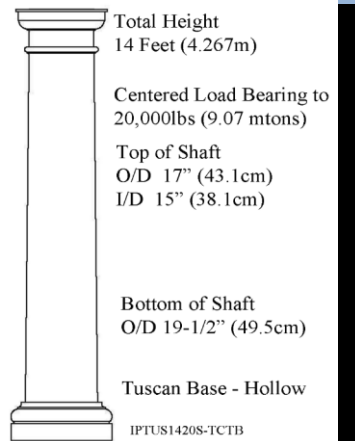
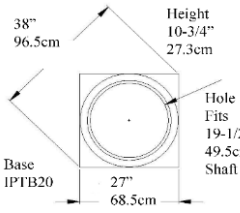
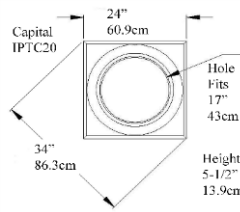

Custom Tapered PDF Form Composite

[click for Drawing / Order Form](#)

IPPC1420S-TBTC 14 Feet 19-3/4" Tapered			
FRP-PolyComp™	List	Each	6 +
Whole	5879.39	4409.54	3527.63
Split in Half (Pilaster)	6058.08	4543.56	3634.85
Whole White Painted	7095.63	5321.72	4257.38
Split in Half White Painted	7274.32	5455.74	4364.59

ITEM 14-15

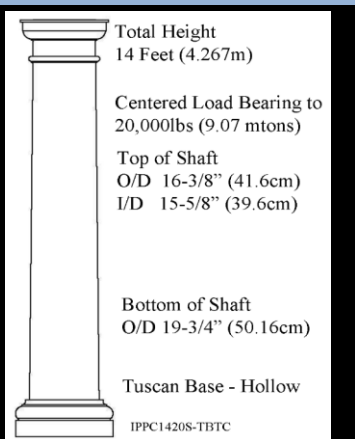
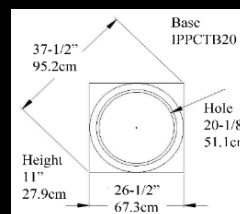
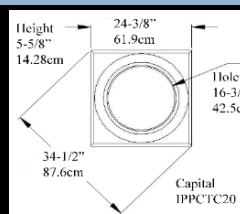

[click for Drawing / Order Form](#)

IPPC1424S-TBTC 14 Feet 23-3/4" Tapered			
FRP-PolyComp™	List	Each	6 +
Whole	7445.72	5584.29	4467.43
Split in Half (Pilaster)	7705.87	5779.40	4623.52
Whole White Painted	9068.52	6801.39	5441.11
Split in Half White Painted	9328.61	6996.45	5597.16

ITEM 14-16

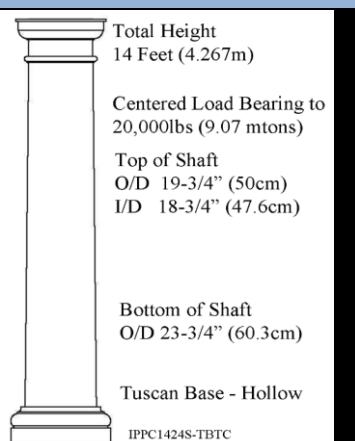
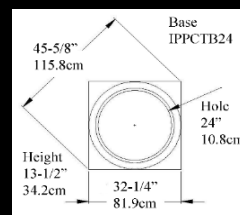
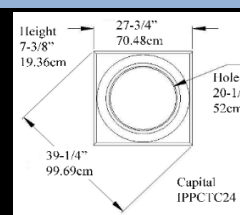

[click for Drawing / Order Form](#)

## 24 HARDWOODS (Hollow with Load Options)

Hardwoods are a Green Choice

Exterior Woods: Pine, Western Red Cedar, White Oak

Interior Woods:

Poplar, Bass, Red Oak, Maple, SapMaple, Ash  
Cherry, African Mahogany, Walnut, Yellow Birch

### Benefits

Total Customization to the Micro Inch  
Solid Capitals and Bases



[Watch Youtube Video](#)

## PolyComp & FiberComp™ (Load Bearing)

FiberComp™ is made from 75% calcium carbonate

25% Fiberglass Resins

Capitals & Bases EconPolymer™ - not primed

All Whole Columns are Load Bearing

Always consult with your structural engineer for application

### Benefits

Insect, Rot and Water Resistant

Minimal Thermal Transfer to avoid spider cracks

Optional Split for Post Wrap, Cut to Height or Corner Cuts



[Watch Youtube Video](#)

## ArchPolymer™ a Decorative Faux Wood

ArchPolymer™ is high density Polyurethane

Lite weight - easy to cut and install for post wrap

Perfect for Theatres, Store Fixtures, Gardens

Not Load Bearing

### Benefits

Insect, Rot and Water Resistant

Minimal Thermal Transfer to avoid spider cracks



[Watch Youtube Video](#)

## StoneMold™ & Zeament™ Décor Post Wrap

Architectural Artificial Stone Composite Interior Use only

made from Alpha Gypsum Cement with pigment

Not Load Bearing

Columns split with a reveal at the seam

SM: 12 Finishes

ZM: 11 Finishes



[Watch Youtube Video](#)



# Hardwood: Tuscan Non-Tapered Custom Size Form (Smooth or Fluted)



<= A Part 1) A = Top Square  
 Width: \_\_\_\_\_ Depth: \_\_\_\_\_  
 Height: \_\_\_\_\_  
 with Bevel or No Bevel

made in 5 Parts

I = Total Height all Parts: \_\_\_\_\_

Part 2) B = Top Round  
 Diameter: \_\_\_\_\_  
 Height: \_\_\_\_\_

Hardwood Specifications  
 Select & Better Grade  
 Sanded to 120

Kiln Dried to 7-8%, 12 staves  
 No Centers used, Riff Sawn

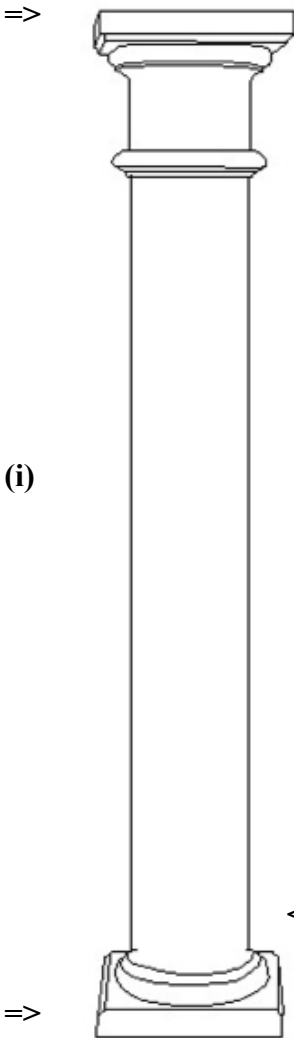

<= C PART 3 -SHAFT  
 <= D Shaft Type Circle  
 <= E Smooth or 12 Flutes 24 Flutes  
 <= F

**Circle Hardwood**

**Interior Use**

Paint Grade:  
 Basswood Maple AmPoplar

C= Top Ring  
 Diameter: \_\_\_\_\_ Height: \_\_\_\_\_

Stain Grade:  
 Sap Maple  
 Red Oak / White Oak  
 Alder  
 Cherry  
 Beech  
 Walnut  
 African Mahogany  
 Ash  
 Yellow Birch

D = Neck Top of Shaft  
 Diameter: \_\_\_\_\_  
 Length: \_\_\_\_\_

E = Astragal  
 Diameter: \_\_\_\_\_  
 Height: \_\_\_\_\_

F & G = \_\_\_\_\_  
 Shaft Diameter \_\_\_\_\_

**Exterior Use**

Knotty Pine  
 White Pine  
 Clear Pine  
 Western Red Cedar

<= G PART 4  
 H = Bottom Round  
 Diameter: \_\_\_\_\_  
 Height: \_\_\_\_\_

How many \_\_\_\_\_

Whole Columns \_\_\_\_\_

PART 5 I = Bottom Square  
 Width: \_\_\_\_\_

Split for Post Wrap \_\_\_\_\_

<= H Depth: \_\_\_\_\_

How many Split for Pilaster  
 (up against a wall) \_\_\_\_\_

<= I Height: \_\_\_\_\_  
 with Bevel or No Bevel



Imperial Productions®

1-800-399-7585

Imperial Productions & Distribution Inc New York & Toronto

email sales@imperialproductions.com copyright 2016 MRDCI All Rights Reserved

HW-TUS-NTAP

JUL-21



# Hardwood: Tuscan Tapered Custom Size Form (Smooth or Fluted)

A =>

B =>



Imperial  
Productions®

Part 1) A = Top Square Capital

Width: \_\_\_\_\_

Depth: \_\_\_\_\_

Height: \_\_\_\_\_

with Bevel or No Bevel

made in 5 Parts

Total Height all Parts: \_\_\_\_\_

Part 2) B = Top Round

Diameter: \_\_\_\_\_

Height: \_\_\_\_\_

Hardwood Specifications

Select & Better Grade

Sanded to 120

Kiln Dried to 7-8%, 12 staves

No Centers used, Riff Sawn

PART 3 -SHAFT

Shaft Type Circle

Smooth or 12 Flutes 24 Flutes

**Circle Hardwood**

Interior Use

Paint Grade:

Basswood Maple AmPoplar

Stain Grade:

Maple

Sap Maple

Red Oak / White Oak

Alder

Cherry

Beech

Walnut

African Mahogany

Ash

Yellow Birch

A =>

C =>

F =>

G =>

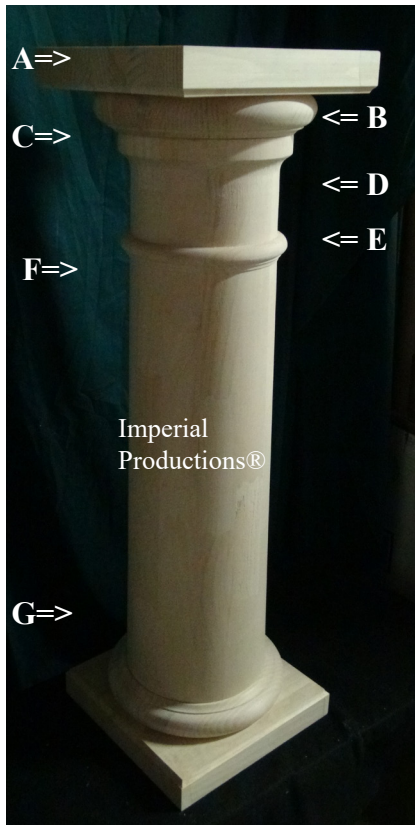

Imperial  
Productions®

C= Top Ring

Diameter: \_\_\_\_\_ Height: \_\_\_\_\_

D = Neck Top of Shaft

Diameter: \_\_\_\_\_

Length: \_\_\_\_\_

E = Astragal

Diameter: \_\_\_\_\_

Height: \_\_\_\_\_

F = Top of Shaft

Diameter: \_\_\_\_\_

Enthasis Tapered

Taper Stops 2/3rds down shaft

G = Bottom of Shaft

Diameter: \_\_\_\_\_

Exterior Use

Knotty Pine

White Pine

White Oak

Clear Pine

Western Red Cedar

PART 4

H = Bottom Round with cove

Diameter: \_\_\_\_\_

Height: \_\_\_\_\_

Whole Columns # \_\_\_\_\_

Split for Post Wrap \_\_\_\_\_

PART 5 I = Bottom Square

Width: \_\_\_\_\_ Depth: \_\_\_\_\_

How many Split for Pilaster  
(up against a wall)

Height: \_\_\_\_\_

H =>

i =>



Imperial  
Productions®

with Bevel or No Bevel



Imperial Productions®

1-800-399-7585

Imperial Productions & Distribution Inc Toronto / New York

email sales@imperialproductions.com copyright 2016 MRDCI All Rights Reserved

HW-TUS-TAP

JUL-21



# Composite Tuscan Tapered Custom Size Form (Smooth or Fluted)

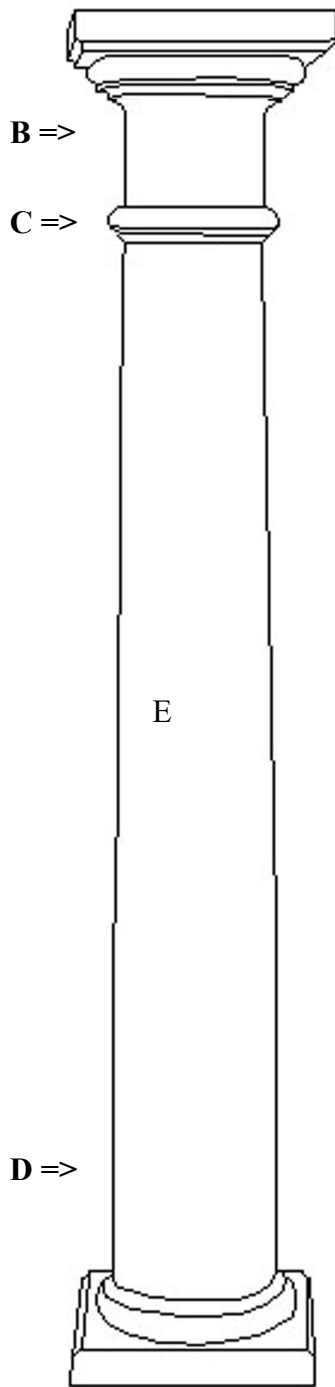

A)  
Utilize Standard Capital



SHAFT B= Top Diameter

---

C = Astragal (*circle*)

Yes or No

Enthasis Tapered  
Taper Stops 2/3rds down shaft  
or Distance

E) Shaft Height:

---

E) Shaft Type (*circle*)

Smooth or Fluted

D = Bottom of Shaft  
Diameter:

---

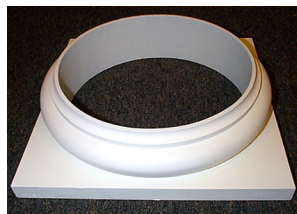

Utilize Standard Base

made in 3 Parts

Total Height all Parts: \_\_\_\_\_

How many Whole Columns \_\_\_\_\_

Split for Inside Corner # \_\_\_\_\_

Split for Wall Wrap # \_\_\_\_\_

Split for Outside Corner # \_\_\_\_\_

Split for Engaged Pilaster  
What Percentage Cut

in Half

or \_\_\_\_\_ %



Split for inside Corner



Split for Wall Wrap



Split for Wall Wrap



Engaged



Imperial Productions®

1-800-399-7585

Imperial Productions & Distribution Inc Toronto / New York

email sales@imperialproductions.com copyright 2016 MRDCI All Rights Reserved

FG-TUS-TAP

JUL-21



# Composite Non Tapered Custom Size Form (Smooth or Fluted)



<=  
Astragal  
Fit Here

Utilize Standard Capital



SHAFT  
Top & Bottom Diameter

\_\_\_\_\_

Astragal (*Circle*)

Yes or No

Shaft Height:

\_\_\_\_\_

Shaft Type: (*Circle*)

Fluted or Smooth

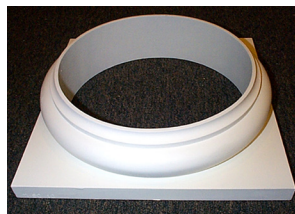

Utilize Standard Base

made in 3 Parts

Total Height all Parts: \_\_\_\_\_

How many Whole Columns \_\_\_\_\_

Split for Inside Corner # \_\_\_\_\_

Split for Wall Wrap # \_\_\_\_\_

Split for Outside Corner # \_\_\_\_\_

Split for Engaged Pilaster  
What Percentage Cut

in Half

or \_\_\_\_\_ %



Split for inside Corner



Split for Wall Wrap



Split for Wall Wrap



Engaged



Imperial Productions®

1-800-399-7585

Imperial Productions & Distribution Inc Toronto / New York

email sales@imperialproductions.com copyright 2016 MRDCI All Rights Reserved

FG-TUS-NTAP

JUL-2021

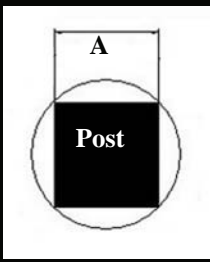

# Post Wrap Chart

## 4 x 4 Square Wood Dressed

Dressed to 3-1/2" x 3-1/2" (8.8 x 8.8cm)

A) Inside Minimum Top of Shaft 5" (12.7cm)

## 6 x 6 Square Wood Dressed

Dressed 5-1/2" x 5-1/2" (13.9 x 13.9cm)

A) Minimum Inside Top of Shaft  
7-3/4" (19.68cm)

## 4 x 4 Square Steel Post

A) Inside Minimum Top of Shaft  
5-3/4" (14.6cm)

## 6 x 6 Square Steel Post

A) Inside Minimum Inside Top of Shaft  
8-5/8" (21.9cm)

## 8 x 8 Square Wood Dressed

Dressed 7-1/2" x 7-1/2" (19 x 19cm)

A) Inside Minimum 11-1/2" (29.21cm)



Do not measure too tight as you need to take into account manufacturing tolerances that can be up to 1/4" (.63cm) minimum Dressed sizes as per AWC Properties of Structural Lumber S4S ([www.AWC.org](http://www.AWC.org))

# We Sell Steel Posts Galvanized or Primed

## Specify Heights, Round or Square Top & Bottom Plates

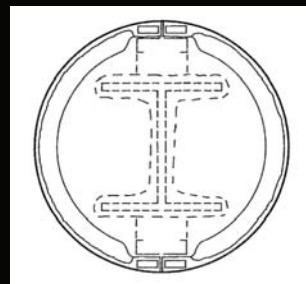

### Post Wrap:

- \* Pressure Treated Wood Posts 4x4, 6x6
- \* I-Beams
- \* Round Metal
- \* Square Metal

### Design Tip:

Consider a post wrap. This gets the framing inspection complete then follow up with the decorative finished column cover once the inspector signs off.



**Imperial Productions®**

1-800-399-7585

Imperial Productions & Distribution Inc Toronto / New York

email [sales@imperialproductions.com](mailto:sales@imperialproductions.com) copyright 2016 MRDCI All Rights Reserved

FG-TUS-NTAP  
JUL-2021





# Imperial Productions® Request for Quote

Download, Fill-in & Email to [sales@imperialproductions.com](mailto:sales@imperialproductions.com)

Name / Company: \_\_\_\_\_

Phone \_\_\_\_\_ Email \_\_\_\_\_

Billing Address: \_\_\_\_\_

City: \_\_\_\_\_ Prov / State \_\_\_\_\_

PC / Zip Code \_\_\_\_\_

Ship to Address: \_\_\_\_\_

City: \_\_\_\_\_ Prov / State \_\_\_\_\_

PC / Zip Code \_\_\_\_\_

Product Code: \_\_\_\_\_

Quantity: \_\_\_\_\_

Notes: \_\_\_\_\_



Imperial Productions®

1-800-399-7585

Imperial Productions & Distribution Inc Toronto / New York

email [sales@imperialproductions.com](mailto:sales@imperialproductions.com) copyright 2016 MRDCI All Rights Reserved