



Imperial Productions®



# Scamozzi Capitals

## Load Bearing and Decorative



Scamozzi is a classical style based on the Ionic Order. In simple terms it is an Ionic capital with 4 scrolls or volutes. The style was created by architect Vincenzo Scamozzi in the 16th century. Composite capitals are made from molds.

Hardwood Solid, ArchPolymer - Hollow Shaft goes inside  
PolyComp are load bearing and sit on top of the shaft



SPLIT OPTIONS



IPCPSCA4		Solid Bottom Ring 4-1/2"		
<b>Interior Hardwood</b>		List	Each	50 +
Hard Maple		401.56	76.17	60.93
Red Oak		140.21	105.16	84.13
Alder		140.21	105.16	84.13
Cherry		163.70	122.78	98.22
Walnut		227.47	170.60	136.48
White Oak		149.94	112.43	89.94
<b>ArchPolymer™</b>				
ArchPolymer		Custom Priced		
GRG-NeoPlaster		Custom Scamozzi Form		

ITEM 1

[click for Drawing/Order Form](#)

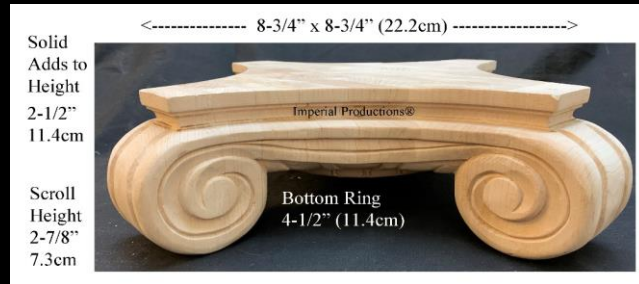

IPCPSCA5		Solid Bottom Ring 5-5/8"		
<b>Interior Hardwood</b>		List	Each	50 +
Hard Maple		132.83	99.62	79.70
Red Oak		132.83	99.62	79.70
Alder		132.83	99.62	79.70
Cherry		176.75	132.56	106.05
Walnut		235.61	176.71	141.37
White Oak		144.25	108.19	86.55
<b>ArchPolymer™</b>				
ArchPolymer™ Composite		Custom Priced		
GRG-NeoPlaster		Custom Scamozzi Form		

ITEM 2

[click for Drawing/Order Form](#)



IPSCA298-Décor		Fits 6" Column		
<b>ArchPolymer™</b>		List	Each	50 +
ArchPolymer™ Composite		173.73	130.29	104.24
Plaster		225.23	168.92	135.14

ITEM 3

[click for Drawing/Order Form](#)

Custom Scamozzi Form

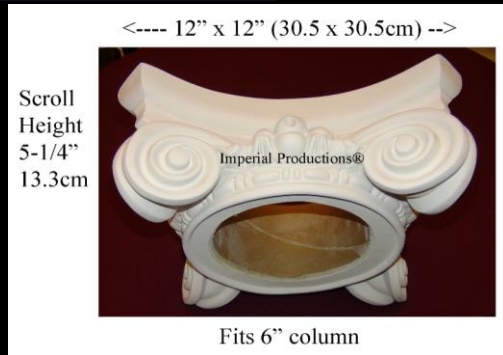
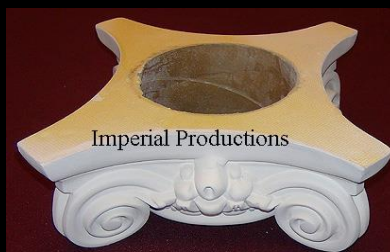
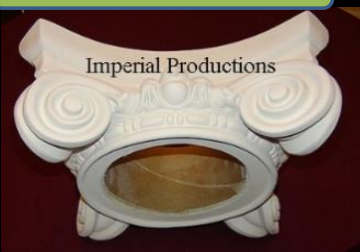

IPSCA100-Décor		O/D Bottom Ring 7-1/4"		
<b>ArchPolymer™</b>		List	Each	50 +
Whole (Primed White)		155.87	116.90	93.52
Factory Spray Painted		Custom Priced Specify RAL#		
GRG-NeoPlaster™		Custom Priced		

ITEM 4

[click for Drawing/Order Form](#)

Custom Scamozzi Form

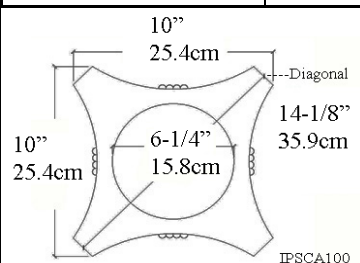



IPSCA299-Décor	O/D Bottom Ring 7-1/4"		
<b>ArchPolymer™</b>	List	Each	50 +
ArchPolymer™ Composite	<del>200.05</del>	150.04	120.03
Plaster	262.08	196.56	157.25

ITEM 5

[click for Drawing/Order Form](#)

[Custom Scamozzi Form](#)

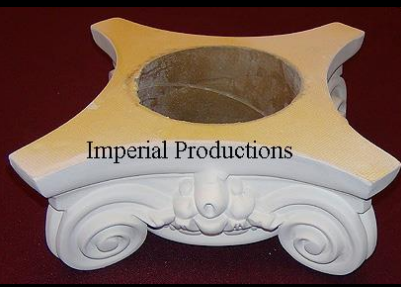
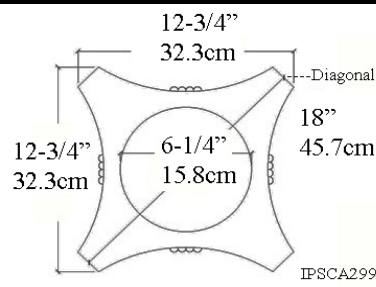

Scroll Height 5-1/4" 13.3cm  
Mid Height 4" 10cm



Bottom Ring 7-1/4" (18.4cm)

IPSCA008-Décor	O/D Bottom Ring 6-1/4"		
<b>ECON-POLYMER</b>	List	Each	50 +
Whole	<del>465.86</del>	455.61	465.86
Split for Post Wrap	<del>550.94</del>	538.79	550.91
Split in Half (Pilaster)	<del>550.94</del>	538.79	550.91

ITEM 6

[click for Drawing/Order Form](#)

[Custom Scamozzi Form](#)

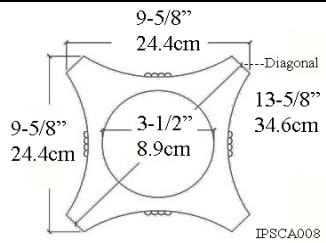

Mid Height 3" 7.6cm



Scroll Height 4-1/4" 10.8cm

O/D Bottom Ring 6-1/4" (15.8cm)

IPPCSC08-Load	O/D Load Ring 6-1/2"		
<b>FRP-PolyComp™</b>	List	Each	50 +
Whole	<del>366.59</del>	274.95	219.96
Split in Half (Pilaster)	<del>429.94</del>	322.46	257.97
Whole White Painted	<del>390.10</del>	292.58	234.06
Split in Half White Painted	<del>453.48</del>	340.11	272.09

ITEM 7

[click for Drawing/Order Form](#)

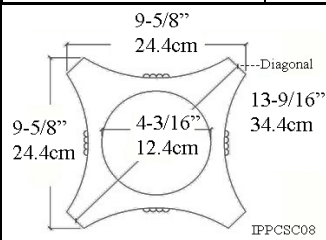

Load Bearing to 10,000 lbs (4.5mtons)

3-1/8" 7.9cm



Round Bottom Ring 6-1/2" (16.5cm)

IPSCA150-Décor	O/D Bottom Ring 7-3/4"		
<b>ArchPolymer™</b>	List	Each	50 +
Whole (Primed White)	<del>163.54</del>	122.63	98.10

ITEM 8

[click for Drawing/Order Form](#)

[Custom Scamozzi Form](#)

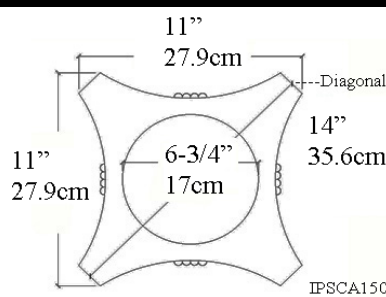

3-1/4" 8.3cm



Scroll Height 4-5/8" 11.7cm

Round Bottom Ring 7-3/4" (19.7cm)



IPSCA151-Décor	O/D Bottom Ring 7-3/4"		
ArchPolymer™	List	Each	50 +
Whole (Primed White)	<b>167.05</b>	125.29	100.23

ITEM 9

[click for Drawing/Order Form](#)

Custom Scamozzi Form

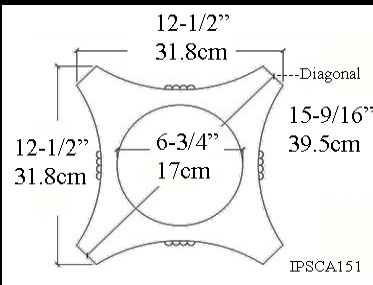

IPSCA149-Décor	O/D Bottom Ring 9"		
ArchPolymer™	List	Each	50 +
Whole (Primed White)	<b>200.64</b>	125.29	100.23

ITEM 10

[click for Drawing/Order Form](#)

Custom Scamozzi Form

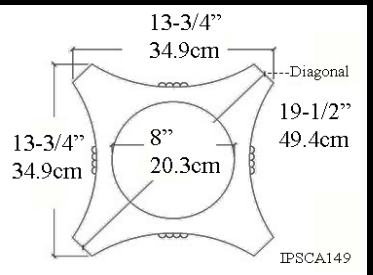

IPSCA300-Décor	O/D Bottom Ring 9"		
ArchPolymer™	List	Each	50 +
ArchPolymer™ Composite	<b>303.89</b>	227.92	182.33
Plaster	407.45	305.59	244.47

ITEM 11

[click for Drawing/Order Form](#)

Custom Scamozzi Form

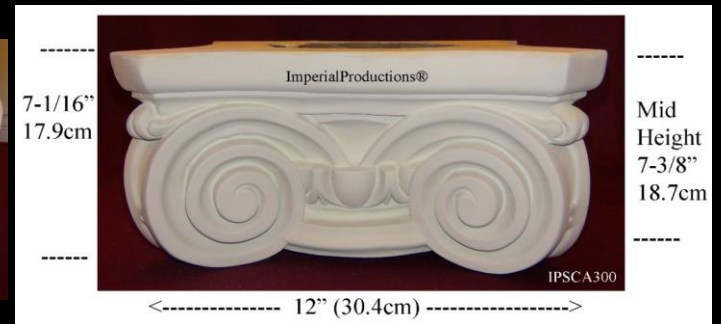
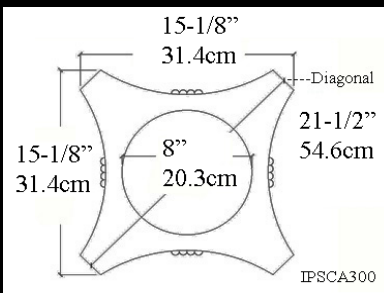

IPSCA103-Décor	O/D Bottom Ring 9-1/4"		
ArchPolymer™	List	Each	50 +
Whole (Primed White)	<b>197.03</b>	147.77	118.22
Factory Spray Painted	Custom Priced Specify RAL#		
GRG-NeoPlaster™	Custom Priced		

ITEM 12

[click for Drawing/Order Form](#)

Custom Scamozzi Form

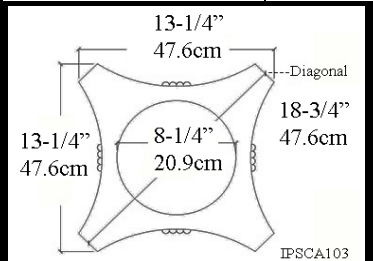



IPPCSC10-Load	O/D Load Ring 8-3/4"		
FRP-PolyComp™	List	Each	50 +
Whole	547.80	410.85	328.68
Split in Half (Pilaster)	611.21	458.41	366.73
Whole White Painted	583.67	437.75	350.20
Split in Half White Painted	647.08	485.31	388.25

ITEM 13

[click for Drawing/Order Form](#)

Load Bearing

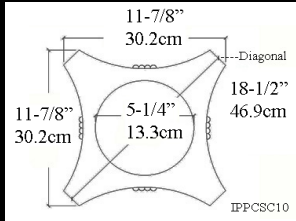

Load Bearing to 14,000 lbs (6.45mtons)



Round Bottom Ring 8-3/4" (22.2cm)

IPSCA010-Décor	O/D Bottom Ring 8-7/8"		
ECON-POLYMER	List	Each	50 +
Whole	660.85	646.31	660.85
Split for Post Wrap	745.90	729.49	745.90
Split in Half (Pilaster)	745.90	729.49	745.90

ITEM 14

[click for Drawing/Order Form](#)

Custom Scamozzi Form

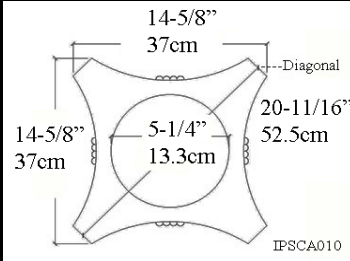

O/D Bottom Ring 8-7/8" (22.5cm)

IPSCA153-Décor	O/D Bottom Ring 10"		
ArchPolymer™	List	Each	50 +
Whole (Primed White)	264.52	198.39	158.71

ITEM 15

[click for Drawing/Order Form](#)

Custom Scamozzi Form

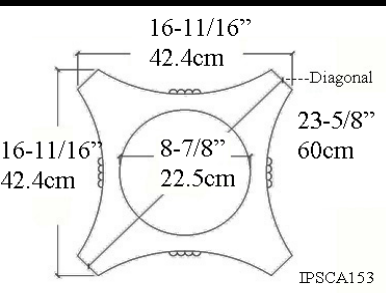

Round Bottom Ring 10" (25.4cm)

IPPCSC12-LOAD	O/D Load Ring 9-3/4"		
FRP-PolyComp™	List	Each	50 +
Whole	770.20	577.65	462.12
Whole White Painted	831.75	623.81	499.05
Split in Half (Pilaster)	833.60	625.20	500.16
Split in Half White Painted	895.15	671.36	537.09

ITEM 16

[click for Drawing/Order Form](#)

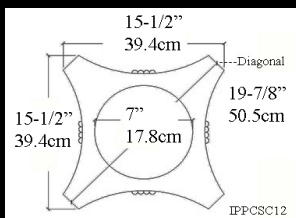

Load Bearing to 18,000 lbs (8.16mtons)



Round Bottom Ring 9-3/4" (24.8cm)



IPMRD9000-Décor	O/D Bottom Ring 11"		
ArchPolymer™	List	Each	50 +
Whole (Primed White)	172.93	129.69	103.76

ITEM 17

[click for Drawing/Order Form](#)

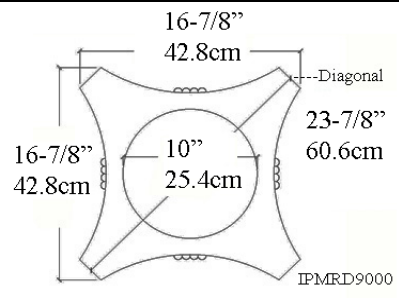

Center Height 5" 12.7cm



Scroll Height 7" 17.7cm

Round Bottom Ring 11" (27.9cm)

IPSCA152-Décor	O/D Bottom Ring 11"		
ArchPolymer™	List	Each	50 +
Whole (Primed White)	219.72	164.79	131.83

ITEM 18

[click for Drawing/Order Form](#)

Custom Scamozzi Form

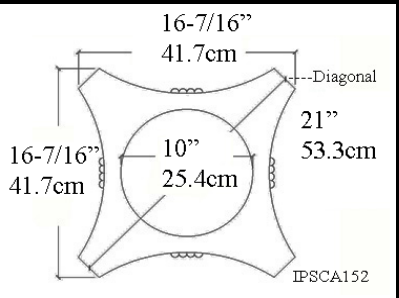

Center Height 4-3/4" 12cm



Scroll Height 6-3/4" 17cm

Round Bottom Ring 11" (27.9cm)

IPPCSC14-LOAD	O/D Load Ring 10-1/4"		
FRP-PolyComp™	List	Each	50 +
Whole	1053.65	790.24	632.19
Split in Half (Pilaster)	4117.80	838.35	670.68
Whole White Painted	4121.81	841.35	673.08
Split in Half White Painted	4185.96	889.47	711.57

ITEM 19

[click for Drawing/Order Form](#)

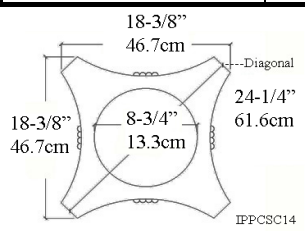

Load Bearing to 18,000 lbs (8.16mtons)

Center Height 5-1/2" 14cm



Scroll Height 7-7/8" 20cm

Round Bottom Ring 10-1/4" (26cm)

IPSCA012-Décor	O/D Bottom Ring 10-1/2"		
ECON-POLYMER	List	Each	50 +
Whole	731.26	548.44	438.76
Split for Post Wrap	816.34	612.23	489.79
Split in Half (Pilaster)	816.34	612.23	489.79

ITEM 20

[click for Drawing/Order Form](#)

Custom Scamozzi Form

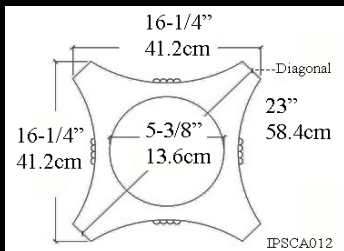

Center Height 5-1/8" 13cm



Scroll Height 7-1/4" 18.4cm

O/D Bottom Ring 10-1/2" (26.7cm)



IPSCA105-Décor	O/D Bottom Ring 11-1/4"		
ArchPolymer™	List	Each	50 +
Whole (Primed White)	400.77	300.58	240.46
Factory Spray Painted	Custom Priced Specify RAL#		
GRG-NeoPlaster™	Custom Priced		

ITEM 21

[click for Drawing /Order Form](#)

[Custom Scamozzi Form](#)

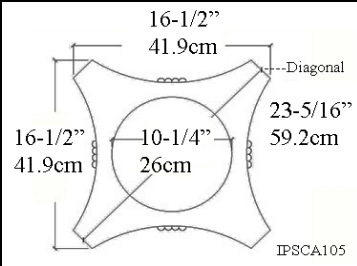

Center Height 5" 12.7cm



Scroll Height 7-1/4" 18.4cm

Bottom Ring 11-1/4" (28.6cm)

IPSCA154-Décor	O/D Bottom Ring 11-1/2"		
ArchPolymer™	List	Each	50 +
Whole (Primed White)	375.44	281.56	225.25

ITEM 22

[click for Drawing/Order Form](#)

[Custom Scamozzi Form](#)

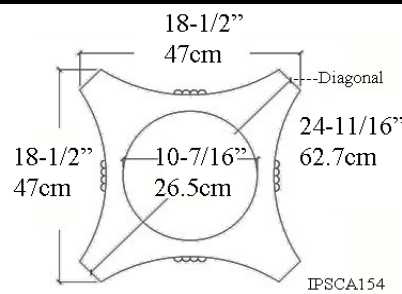

Center Height 5-1/4" 13.3cm



Scroll Height 7-1/2" 19cm

Bottom Ring 11-1/2" (28.6cm)

IPSCA301-Décor	O/D Fits 12"		
ArchPolymer™	List	Each	50 +
ArchPolymer™ Composite	470.44	352.83	282.26
Plaster	604.01	453.01	362.41

ITEM 23

[click for Drawing/Order Form](#)

[Custom Scamozzi Form](#)

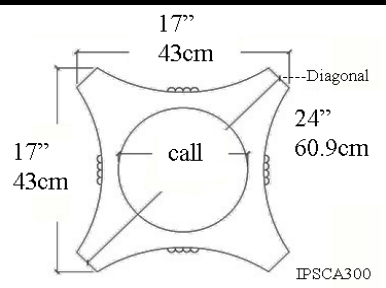

Scroll Height call  
Mid Height call



Bottom Ring call

IPSCA014-Décor	O/D Bottom Ring 12-1/4"		
ECON-POLYMER	List	Each	50 +
Whole	1142.06	856.55	685.24
Split for Post Wrap	1227.12	920.34	736.27
Split in Half (Pilaster)	1227.12	920.34	736.27

ITEM 24

[click for Drawing /Order Form](#)

[Custom Scamozzi Form](#)

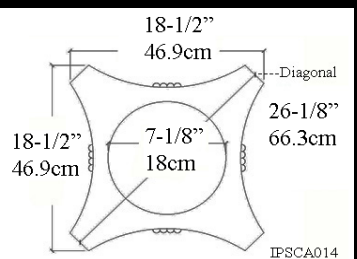

Center Height 5-3/4" 14.6cm



Scroll Height 7-1/2" 19cm

O/D Bottom Ring 12-1/4" (31cm)



<b>IPSCA155-Décor</b>	<b>O/D Bottom Ring 13-1/4"</b>		
<b>ArchPolymer™</b>	List	Each	50 +
Whole (Primed White)	<b>296.15</b>	222.11	177.69

ITEM 25

[click for Drawing/Order Form](#)

[Custom Scamozzi Form](#)

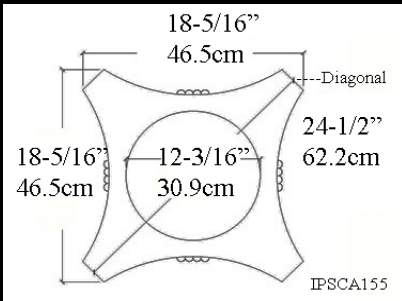

Center Height 5-7/16\"/>



Scroll Height 7-3/4\"/>

Bottom Ring 13-1/4" (33.65cm)

<b>IPSCA106-Décor</b>	<b>O/D Bottom Ring 11-1/4"</b>		
<b>ArchPolymer™</b>	List	Each	50 +
Whole (Primed White)	<b>491.86</b>	368.90	295.12
Factory Spray Painted	Custom Priced Specify RAL#		
GRG-NeoPlaster™	Custom Priced		

ITEM 26

[click for Drawing/Order Form](#)

[Custom Scamozzi Form](#)

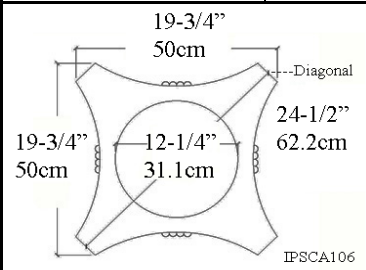

Center Height 6\"/>



Scroll Height 8-1/2\"/>

Bottom Ring 13-1/4" (33.65cm)

<b>IPPCSC16-LOAD</b>	<b>O/D Load Ring 14"</b>		
<b>FRP-PolyComp™</b>	List	Each	50 +
Whole	<b>1824.62</b>	1368.47	1094.77
Whole White Painted	<b>1903.27</b>	1427.45	1141.96
Split in Half (Pilaster)	<b>2128.87</b>	1596.65	1277.32
Split in Half White Painted	<b>2207.52</b>	1655.64	1324.51

ITEM 27

[click for Drawing/Order Form](#)

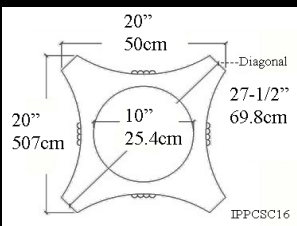

Load Bearing to 18,000 lbs (8.16mtons)

Center Height 6\"/>



Scroll Height 8-1/2\"/>

Round Bottom Ring 14" (35.6cm)

<b>IPSCA107-Décor</b>	<b>O/D Bottom Ring 15-1/4"</b>		
<b>ArchPolymer™</b>	List	Each	50 +
Whole (Primed White)	<b>561.08</b>	420.81	336.65
Factory Spray Painted	Custom Priced Specify RAL#		
GRG-NeoPlaster™	Custom Priced		

ITEM 28

[click for Drawing/Order Form](#)

[Custom Scamozzi Form](#)

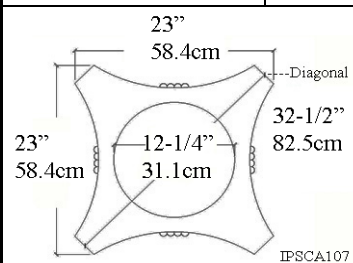

Center Height 7\"/>



Scroll Height 10\"/>

Bottom Ring 15-1/4" (38.7cm)





IPSCA016-Décor	O/D Bottom Ring 12-1/4"		
ECON-POLYMER	List	Each	50 +
Whole	1294.70	971.03	776.82
Split for Post Wrap	1590.45	1192.84	954.27
Split in Half (Pilaster)	1590.45	1192.84	954.27

ITEM 29

[click for Drawing/Order Form](#)

[Custom Scamozzi Form](#)

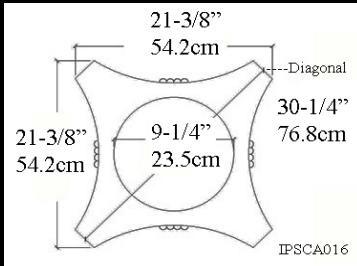

Center Height 5-7/8" 14.9cm



Scroll Height 8-5/8" 21.9cm

O/D Bottom Ring 14-1/4" (36cm)

IPPCSC18-LOAD	O/D Load Ring 15-1/2"		
FRP-PolyComp™	List	Each	50 +
Whole	2242.70	1682.02	1345.62
Split in Half (Pilaster)	2634.15	1975.61	1580.49
Whole White Painted	2339.45	1754.59	1403.67
Split in Half White Painted	2730.93	2048.20	1638.56

ITEM 30

[click for Drawing/Order Form](#)

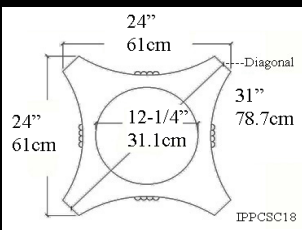

Center Height 7-1/8" 18.1cm



Scroll Height 14-3/4" 37.5cm

Round Bottom Ring 15-1/2" (39.4cm)

IPSCA302-Décor	Fits 16" column		
ArchPolymer™	List	Each	50 +
ArchPolymer™ Composite	887.25	665.44	532.35
Plaster	1187.55	890.66	712.53

ITEM 31

[Custom Scamozzi Form](#)



IPSCA108-Décor	O/D Bottom Ring 17-1/2"		
ArchPolymer™	List	Each	50 +
Whole (Primed White)	601.15	450.86	360.69
Factory Spray Painted	Custom Priced Specify RAL#		
GRG-NeoPlaster™	Custom Priced		

ITEM 32

[click for Drawing/Order Form](#)

[Custom Scamozzi Form](#)

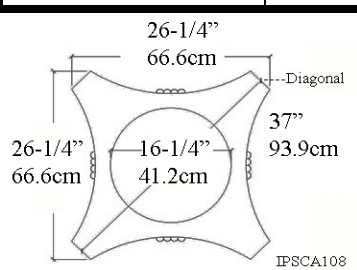

Center Height 8" 20.3cm



Scroll Height 11-1/2" 29.2cm

Bottom Ring 17-1/2" (44.5cm)



IPSCA018-Décor	O/D Bottom Ring 17-1/4"		
ECON-POLYMER	List	Each	50 +
Whole	1914.79	1436.09	1148.87
Split for Post Wrap	2210.54	1657.90	1326.32
Split in Half (Pilaster)	2210.54	1657.90	1326.32

ITEM 33

[click for Drawing/Order Form](#)

[Custom Scamozzi Form](#)

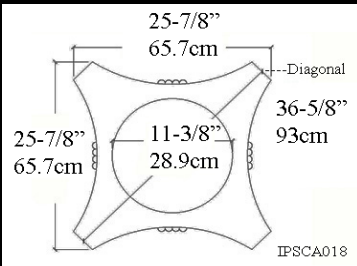

Center Height 7-1/2" 19cm



Scroll Height 10-7/8" 27.6cm

O/D Bottom Ring 17-1/4" (36cm)

IPSCA020-Décor	O/D Bottom Ring 18-5/8"		
ECON-POLYMER	List	Each	50 +
Whole	2818.63	2113.97	1691.18
Split for Post Wrap	3196.96	2397.72	1918.18
Split in Half (Pilaster)	3196.96	2397.72	1918.18

ITEM 34

[click for Drawing/Order Form](#)

[Custom Scamozzi Form](#)

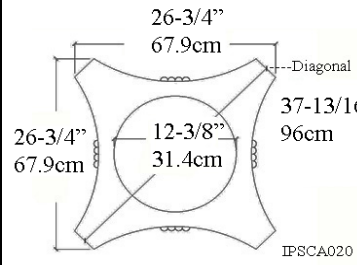

Center Height 8-1/2" 21.5cm



Scroll Height 11" 27.9cm

O/D Bottom Ring 18-5/8" (47.3cm)

IPSCA022-Décor	O/D Bottom Ring 21-1/2"		
ECON-POLYMER	List	Each	50 +
Whole	3503.65	2627.74	2102.19
Split for Post Wrap	3881.99	2911.49	2329.19
Split in Half (Pilaster)	3881.99	2911.49	2329.19

ITEM 35

[click for Drawing/Order Form](#)

[Custom Scamozzi Form](#)

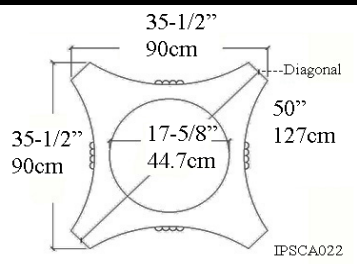

Center Height 11-1/4" 28.5cm



Scroll Height 15-1/4" 38.7cm

O/D Bottom Ring 21-1/2" (54.6cm)

IPSCA024-Décor	O/D Bottom Ring 22-3/4"		
ECON-POLYMER	List	Each	50 +
Whole	4180.91	3135.69	2508.55
Split for Post Wrap	4559.25	3419.44	2735.55
Split in Half (Pilaster)	4559.25	3419.44	2735.55

ITEM 36

[click for Drawing/Order Form](#)

[Custom Scamozzi Form](#)

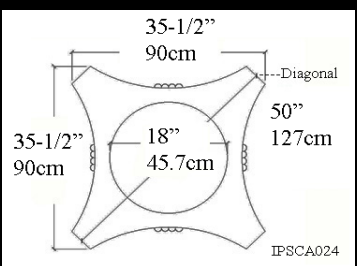

Center Height 11-3/8" 28.9cm



Scroll Height 12-3/4" 32.4cm

O/D Bottom Ring 22-3/4" (57.8cm)



IPSCA030-Décor	O/D Bottom Ring 28"		
ECON-POLYMER	List	Each	50 +
Whole	4924.00	3690.75	2952.60
Split for Post Wrap	5129.22	3846.92	3077.53
Split in Half (Pilaster)	5129.22	3846.92	3077.53

ITEM 37

[click for Drawing/Order Form](#)

[Custom Scamozzi Form](#)

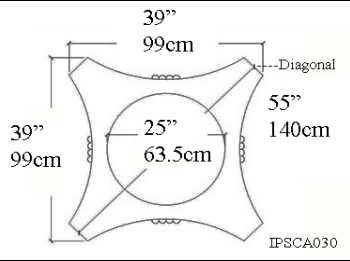

Center Height 15" 38.1cm



Scroll Height 21-1/2" 54.6cm

O/D Bottom Ring 28" (71cm)

IPSCA036-Décor	O/D Bottom Ring 28"		
ECON-POLYMER	List	Each	50 +
Whole	call for pricing		
Split for Post Wrap			
Split in Half (Pilaster)			

ITEM 38

[click for Drawing/Order Form](#)

[Custom Scamozzi Form](#)

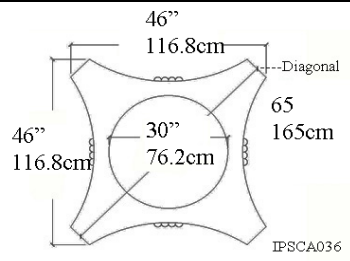

Center Height 15" 38.1cm



Scroll Height 21-1/2" 54.6cm

O/D Bottom Ring 32" (81.28cm)

**Need Gold Leaf ?**  
**Imperial has Ronan**  
**Specialty Paints**  
**call for Details**





# Imperial Productions® Request for Quote

Download, Fill-in & Email to [sales@imperialproductions.com](mailto:sales@imperialproductions.com)

Name / Company: \_\_\_\_\_

Phone \_\_\_\_\_ Email \_\_\_\_\_

Billing Address: \_\_\_\_\_

City: \_\_\_\_\_ Prov / State \_\_\_\_\_

PC / Zip Code \_\_\_\_\_

Ship to Address: \_\_\_\_\_

City: \_\_\_\_\_ Prov / State \_\_\_\_\_

PC / Zip Code \_\_\_\_\_

Product Code: \_\_\_\_\_

Quantity: \_\_\_\_\_

Notes: \_\_\_\_\_



Imperial Productions®

1-800-399-7585

Imperial Productions & Distribution Inc Toronto / New York

email [sales@imperialproductions.com](mailto:sales@imperialproductions.com) copyright 2016 MRDCI All Rights Reserved

Material Properties | **HARDWOODS**

Hardwoods are a Green Choice  
Sanded to 220 Ready to Paint or Stain  
Exterior Woods: Pine, Western Red Cedar, White Oak  
*Interior Woods:*  
Poplar, Bass, Red Oak, Maple, SapMaple, Ash  
Cherry, African Mahogany, Walnut, Yellow Birch

*Benefits*  
Total Customization to the Micro Inch  
Solid Capitals and Bases



[click to Watch Youtube Video](#)

Material Properties | **PolyComp & FiberComp™**

made from 75% calcium carbonate, 25% Fiberglass Resins  
FiberComp™ EconPolymer Caps and Bases (not primed)  
PolyComp™ EconPolymer Caps (paint option)  
All Whole Columns are Load Bearing  
Always consult with your structural engineer for application

*Benefits*  
Insect, Rot and Water Resistant  
Minimal Thermal Transfer to avoid spider cracks  
Optional Split for Post Wrap, Cut to Height or Corner Cuts



[click to Watch Youtube Video](#)

Material Properties | **ArchPolymer™**

ArchPolymer™ is high density Polyurethane  
Lite weight - easy to cut and install for post wrap  
Perfect for Theatres, Store Fixtures, Gardens  
Not Load Bearing  
Primed Ready to Paint by others

*Benefits*  
Insect, Rot and Water Resistant  
Minimal Thermal Transfer to avoid spider cracks



[click to Watch Youtube Video](#)

StoneMold™ & Zeament™ Décor Post Wraps

Architectural Artificial Stone Composite Interior Use only  
made from Alpha Gypsum Cement with pigment  
Not Load Bearing  
Columns split with a reveal at the seam  
12 Finishes                      11 Finishes



[click to Watch Youtube Video](#)