

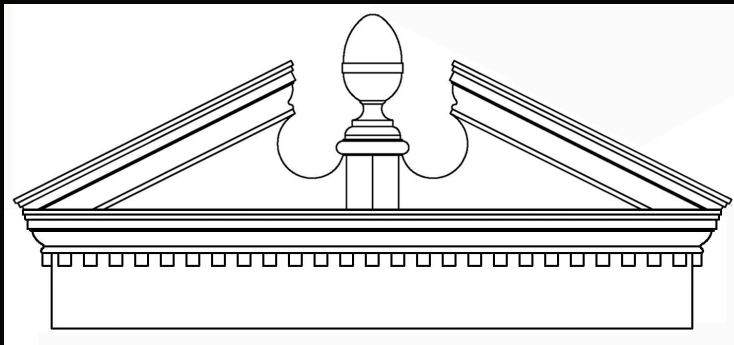

Imperial Productions®

# Custom Acorn Pediments

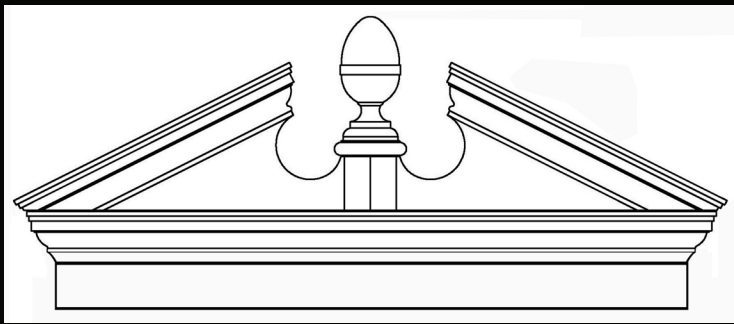
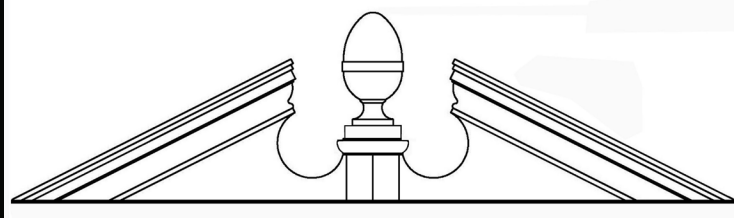

*Materials*

Hardwoods

ArchPolymer™

GRG-NeoPlaster™

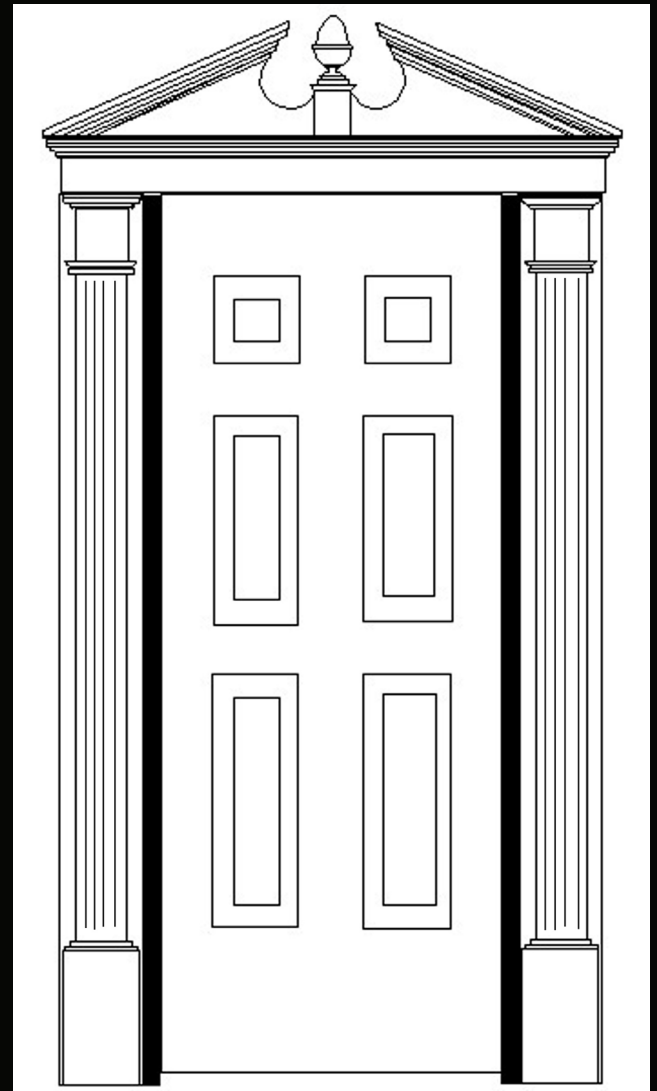

## Fill-in PDF Forms



Imperial Productions®

1-800-399-7585

Imperial Productions & Distribution Inc Toronto / New York

email [sales@imperialproductions.com](mailto:sales@imperialproductions.com) copyright 2016 MRDCI All Rights Reserved



# Acorn Pediment Design # 1A

## Build Your Own with Frieze Board

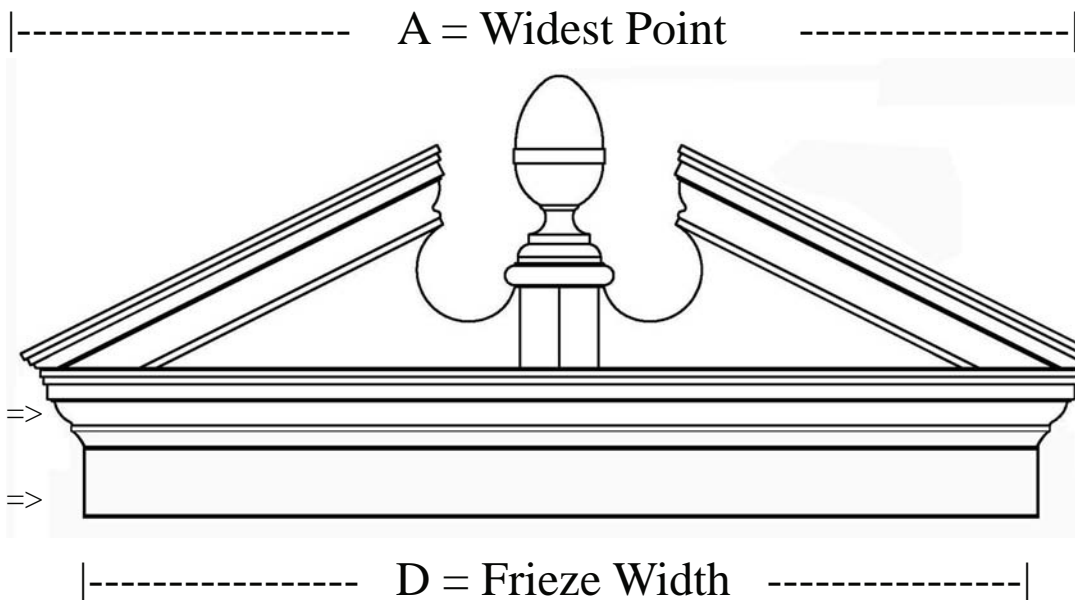
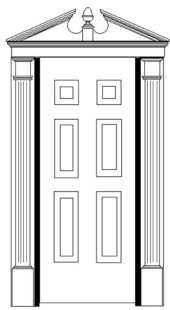

C) TopDepth

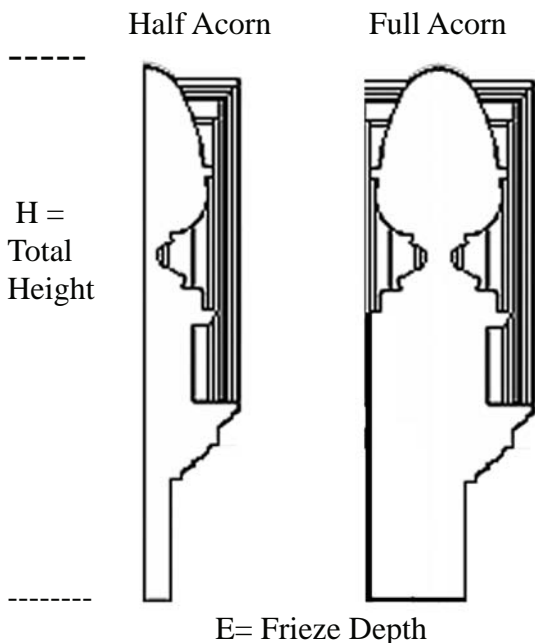

A = Widest Point \_\_\_\_\_

H1 = Cornice Height \_\_\_\_\_

H2 = Frieze Height \_\_\_\_\_

H = Total Height \_\_\_\_\_

C = Top Depth \_\_\_\_\_

E = Frieze Depth \_\_\_\_\_

Full Acorn or 1/2 Acorn (*circle*)

Select Material: ArchPolymer or GRG-NeoPlaster



Imperial Productions®

1-800-399-7585

Imperial Productions & Distribution Inc New York / Toronto

email sales@imperialproductions.com copyright 2016 MRDCI All Rights Reserved



# Acorn Pediment Design # 1B

## Build Your Own with Frieze and Trim

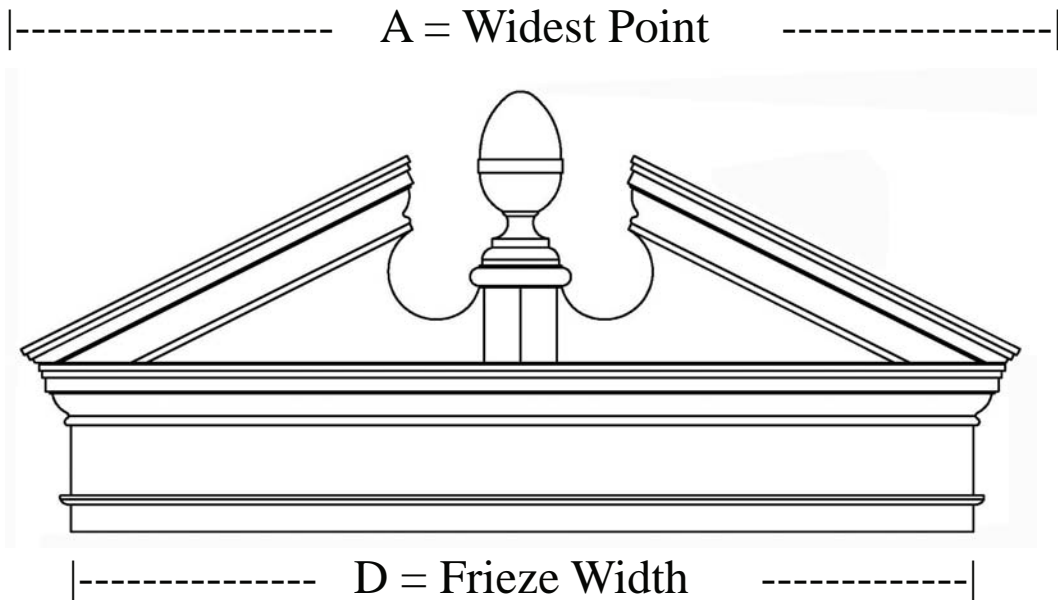
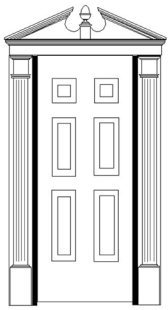

-----  
 H1= Cornice =>  
 -----  
 H2= Frieze =>  
 Board  
 -----

C) TopDepth

Half Acorn

Full Acorn

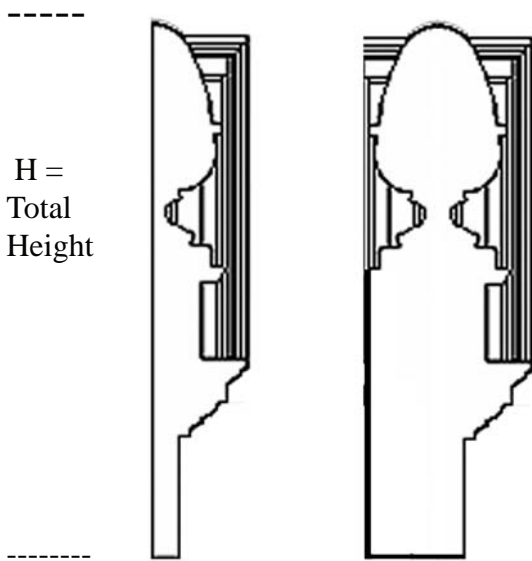

H =  
 Total  
 Height

E= Fascia Depth

A = Widest Point \_\_\_\_\_

H1 = Cornice Height \_\_\_\_\_

H2 = Frieze Height \_\_\_\_\_

H = Total Height \_\_\_\_\_

C = Top Depth \_\_\_\_\_

E = Frieze Depth \_\_\_\_\_

Full Acorn or 1/2 Acorn (*circle*)

Select Material: ArchPolymer or GRG-NeoPlaster



Imperial Productions®

1-800-399-7585

Imperial Productions & Distribution Inc New York / Toronto

email sales@imperialproductions.com copyright 2016 MRDCI All Rights Reserved



# Acorn Pediment Design # 1C

## Build Your Own with Frieze, Trim, Dentil

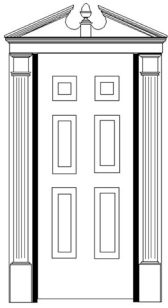

----- A = Widest Point -----

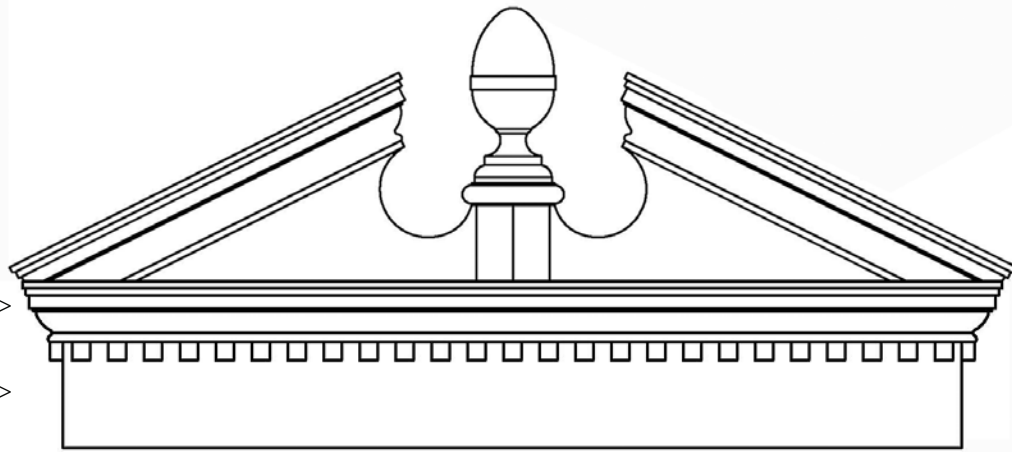

H1= Cornice =>

H2= Frieze =>  
Board

----- D = Frieze Width -----

C) TopDepth

A = Widest Point \_\_\_\_\_

Half Acorn

Full Acorn

H1 = Cornice Height \_\_\_\_\_

H =  
Total  
Height

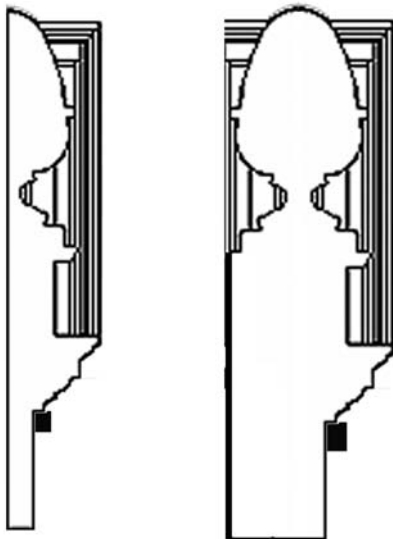

H2 = Frieze Height \_\_\_\_\_

H = Total Height \_\_\_\_\_

C = Top Depth \_\_\_\_\_

E = Frieze Depth \_\_\_\_\_

E= Frieze Depth

Full Acorn or 1/2 Acorn (*circle*)

Select Material: ArchPolymer or GRG-NeoPlaster



Imperial Productions®

1-800-399-7585

Imperial Productions & Distribution Inc New York / Toronto

email sales@imperialproductions.com copyright 2016 MRDCI All Rights Reserved



# Acorn Pediment Design # 2

## Build Your Own

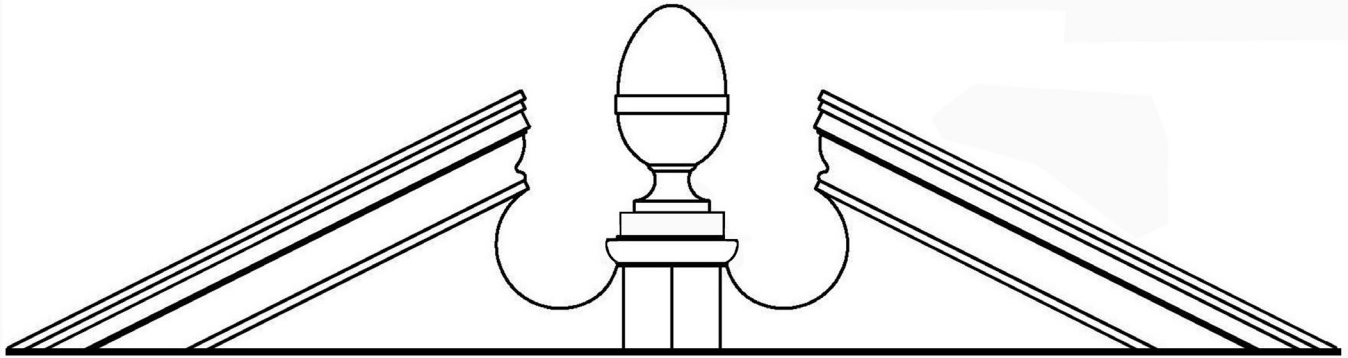

< -----

A) Bottom Width

----->

| - C) Depth

A = Bottom Width \_\_\_\_\_

-----

H = Height \_\_\_\_\_

H =  
Total Height



C = Depth \_\_\_\_\_

-----

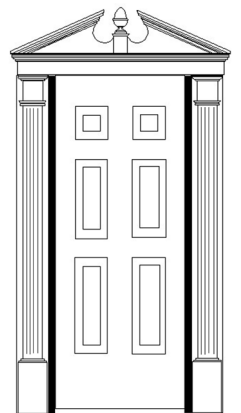

Select Material: ArchPolymer or GRG-NeoPlaster



Imperial Productions®

1-800-399-7585

Imperial Productions & Distribution Inc New York / Toronto

email sales@imperialproductions.com copyright 2016 MRDCI All Rights Reserved



# Acorn Pediment Design # 3

## Build Your Own

----- A = Total Width -----

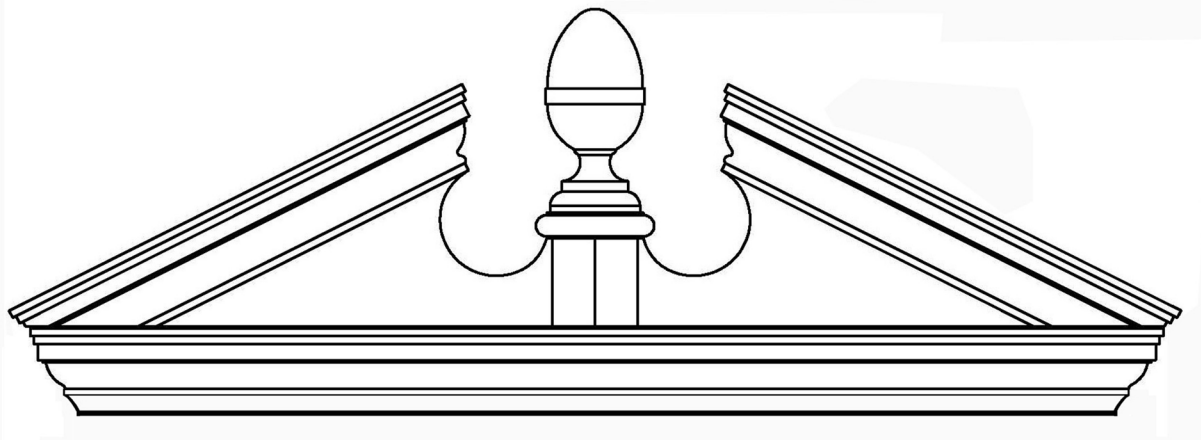

----- D = Moulding Bottom -----

B= Cornice

A = Total Width \_\_\_\_\_

|- C) Depth

B = Cornice Height \_\_\_\_\_

-----

C = Depth \_\_\_\_\_

H =  
Total Height

D = Bottom Moulding



Width \_\_\_\_\_

|E= Facia Depth

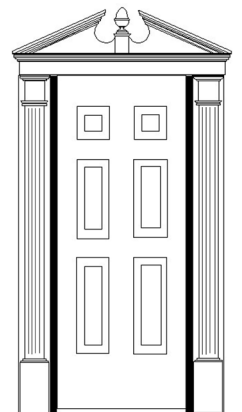

Select Material: ArchPolymer or GRG-NeoPlaster



Imperial Productions®

1-800-399-7585

Imperial Productions & Distribution Inc New York / Toronto

email sales@imperialproductions.com copyright 2016 MRDCI All Rights Reserved



# Imperial Custom Pediment Request for Quote

Company Name: \_\_\_\_\_

Contact: \_\_\_\_\_

Phone: \_\_\_\_\_ Fax: \_\_\_\_\_

Billing Address:

\_\_\_\_\_

City: \_\_\_\_\_ State/Prov \_\_\_\_\_

ZIP (postal code) \_\_\_\_\_

Ship to (If Different)

\_\_\_\_\_

City: \_\_\_\_\_ State/Prov \_\_\_\_\_

ZIP (postal code) \_\_\_\_\_

Usage: Interior or Exterior    How Many \_\_\_\_\_

Material: ArchPolymert<sup>TM</sup>    StoneMold<sup>TM</sup>    NeoPlasterGRG    Zeament<sup>TM</sup>

## PROCEDURE:

We will produce a written quote for your approval. It will be emailed or faxed to you with terms and conditions & payment form. The quote will itemize time lines and freight to your ship to address above.

Local Taxes are charged where applicable, otherwise taxes are your responsibility to remit.

As per our privacy policy all information is kept confidential. Not sold, rented or traded.



Imperial Productions®

1-800-399-7585

Imperial Productions & Distribution Inc    New York / Toronto

email sales@imperialproductions.com    copyright 2016 MRDCI All Rights Reserved