

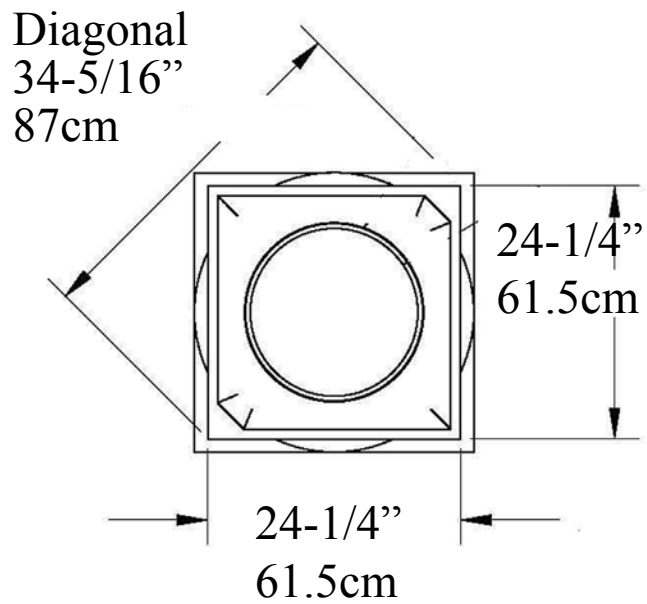

Attic Base IPAB18 EconPolymer™

Martin Richards Design...
COLLECTION



Total Height
11-3/8" (28.8cm)
Top Round: call
Plinth: call



Weight
17 lb
7.72 kg

Made from Molds
Synthetic Polyurethane
Interior & Exterior Use
Insect, Rot, Water Resistant
Same Density as White Pine

* All specifications subject to change without notice,
Final products & Measurements may vary from this brochure Manufacturing tolerances +/- 1/8" (.31cm)



www.imperialarchitecture.com

Imperial Productions & Distribution Inc Toronto / New York

email sales@imperialproductions.com copyright 2016 MRDCI All Rights Reserved

1-800-399-7585

Fall 2018